

Please go to www. quoizel. com for product cleaning tips. Go to the **Care + Maintenance** selection.

Tools Required: Flathead screwdriver, Phillips screwdriver, pliers, wire cutters, wire strippers, electrical tape, safety glasses.

Light Source: (3) Medium Base Vintage Bulbs 60W (supplied), Maximum 100W

Estimated Assembly Time: 30-45 minutes

Preparation: Identify and inspect all parts before beginning installation. Check package content list and diagrams below to be sure all parts are present. If any parts are missing or damaged, do not attempt to assemble, install, or operate the fixture. Contact customer service for replacement parts.

⚠ Warnings and Cautions

Turn off electricity at circuit breaker or main fuse box before installation. Consult a licensed electrician if in doubt.

These instructions are provided for your safety. It is very important you read them completely before installing the fixture. We strongly recommend that a licensed, professional electrician perform the installation.

Disconnect fixture from power source before replacing bulbs. Make sure bulbs are given sufficient time to cool before removal.

Package Contents

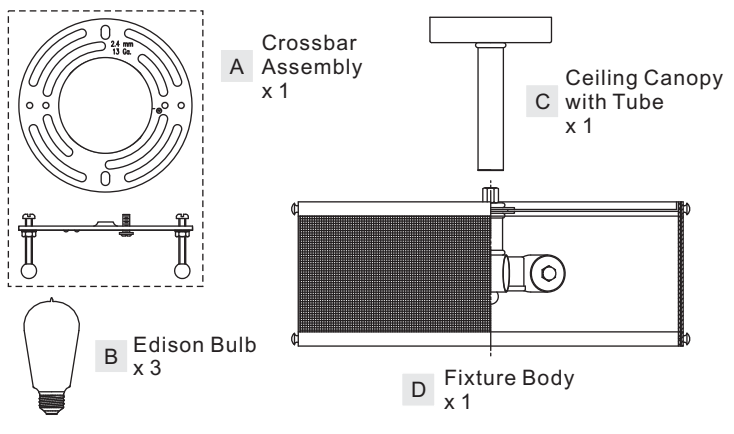

STEP 3 – Test Fitting Ceiling Canopy to Crossbar Assembly

A. Remove mounting balls from the Crossbar Assembly (A). Fit the Ceiling Canopy (C) to the Crossbar Assembly (A) and secure with mounting balls. Note: The Ceiling Canopy (C) should be snug against the ceiling and the mounting balls. If not, adjust the length of the nipple on the Crossbar Assembly (A) by unscrewing the preassembled hex nut and lock washer and then screwing the mounting screws in or out of the crossbar until the correct length is achieved. Once the Ceiling Canopy (C) is secure, remove the mounting ball and Ceiling Canopy (C) and proceed to Step 4.

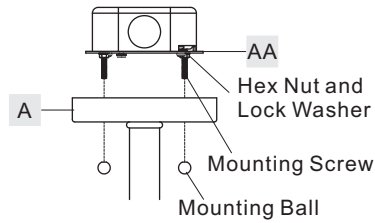

STEP 1 – Install Ceiling Canopy with Tube to Fixture Body

A. Pass supply wire and ground wire through the Ceiling Canopy with Tube (C) and thread the Ceiling Canopy with Tube (C) to the hex coupling on the top center of the Fixture Body (D). Hand tighten until snug.

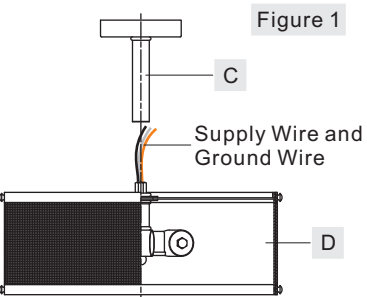

STEP 4 - Wire Connections

A. Wrap bare or green ground wire around green ground screw on the crossbar, no less than 2 inches from the end of the wire. Tighten the green ground screw.
B. Use standard wire connectors (not included) to make all wire connections. Twist connectors until wires are tightly joined together. Wrap each connection with approved electrical tape and carefully stuff all the connected wires into the Outlet Box.

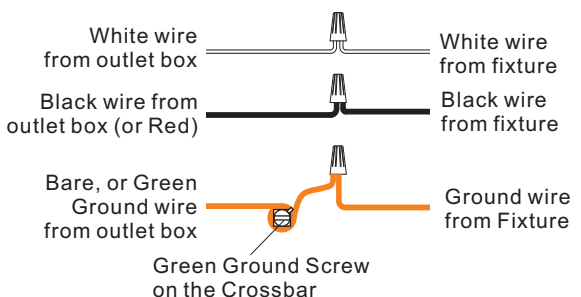

STEP 2 – Install Crossbar Assembly

A. Pass the supply wires through the Crossbar Assembly (AA). Attach the Crossbar Assembly (AA) to the Outlet Box with the head of the Green Ground Screw facing you. Secure it with Outlet Box Screws (not included). Tighten until snug.

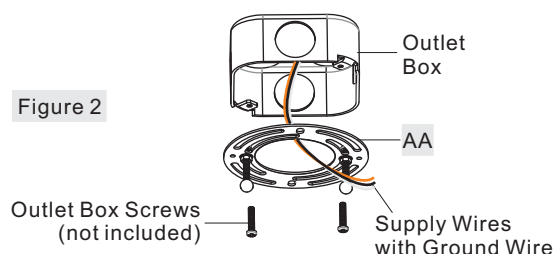

Thank you for purchasing a Quoizel product.
Need assistance with parts or assembly? Call Quoizel customer service at 1-800-645-3184 or visit us on-line at www. quoizel. com

STEP 5 - Install the Fixture

A. Carefully tuck all wires into the outlet box and position the Ceiling Canopy (C) over the outlet box. Align the holes in the Ceiling Canopy (C) with the mounting screws, then attach the Ceiling Canopy (C) using the previously removed mounting balls. Hand tighten until snug.

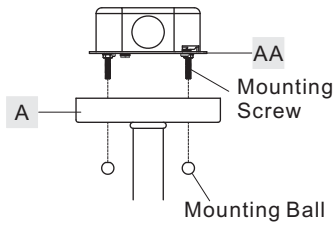

Figure 5

STEP 6 - Install Bulbs

A. Insert bulbs (B) onto sockets and screw snugly into place.

Your fixture is now assembled and ready to use. Enjoy!

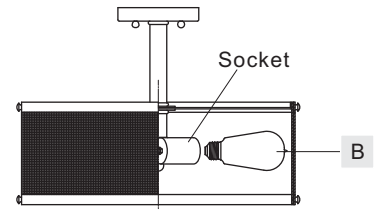
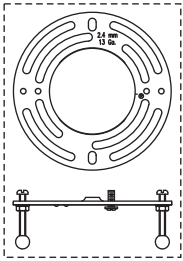

Figure 6

UST1716WT

FINISH: WESTERN BRONZE



NOTE: ALL DIMENSIONS ARE ROUNDED UP TO THE NEAREST 1/4"

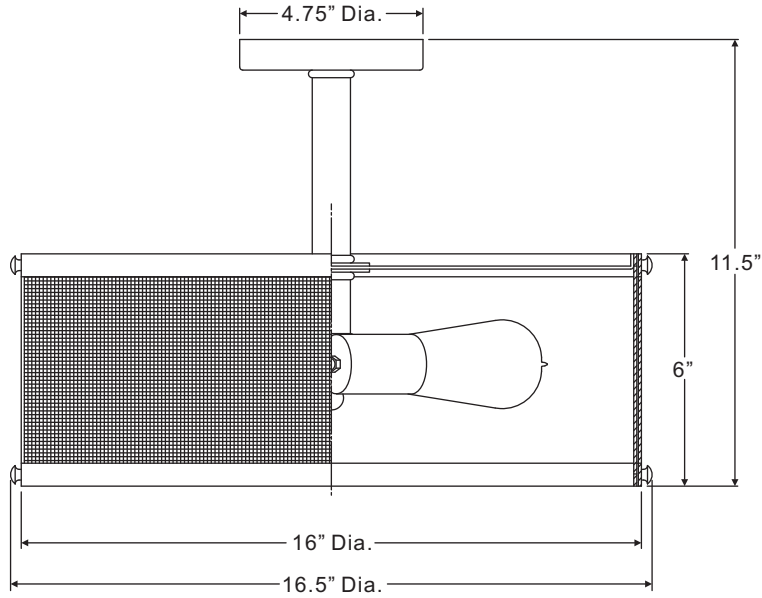

Thank you for purchasing a Quoizel product.
Need assistance with parts or assembly? Call Quoizel customer service at 1-800-645-3184
or visit us on-line at www.quoise.com