

Front view

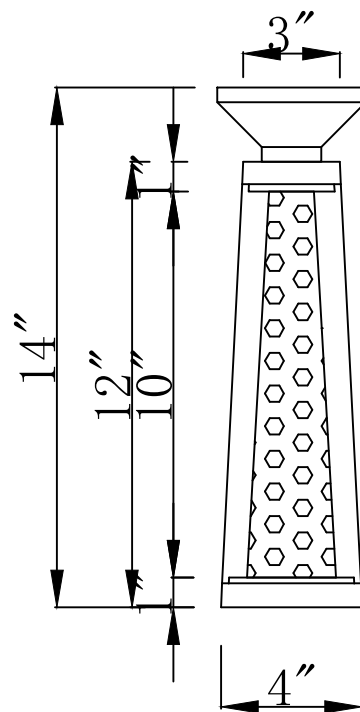

Side view

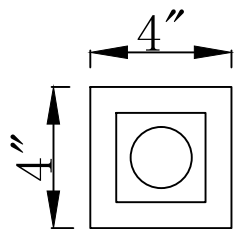

Top view

DWG. NO. :

MODEL NO. :

MR9109

ALTERATIONS

①

②

③

④

FOR PROPOSAL ONLY ALL DIMENSIONS TO BE VERIFIED

SCALE:

DWG. BY:

CHECKED BY:

DATE: Jun20th, 2017

PROJECT:

Qty:

Color:

DRAWINGTITLE:

FINISH:

