

# Assembly Instruction Sheet #IS-9748P59 For Style 9748P59

**Tools Required:** Flathead screwdriver, Phillips screwdriver, pliers, wire cutters, wire strippers, electrical tape, safety glasses  
**Light Source:** (4) LED GU10 MAX 7W ONLY  
**Estimated Assembly Time:** 30-40 minutes  
**Preparation:** Identify and inspect all parts before beginning installation. Check package content list and diagrams below to be sure all parts are present. If any parts are missing or damaged, do not attempt to assemble, install, or operate the fixture. Contact customer service for replacement parts.

## Warnings and Cautions

Turn off electricity at circuit breaker or main fuse box before installation. Consult a licensed electrician if in doubt. These instructions are provided for your safety. It is very important you read them completely before installing the fixture. We strongly recommend that a licensed, professional electrician perform the installation. Disconnect fixture from power source before replacing bulbs. Make sure bulbs are given sufficient time to cool before removal.

## Package Contents

- B L Metal panel x8
- C Screw with capx12
- A Fixture Body x1
- D Wood Panel x2

## Hardware Contents

PART	DESCRIPTION	QUANTITY
BB	Wire Nut	2pcs
CC	Outlet Box Screw	2pcs
DD	Hex Nut	4

## STEP 1 - Fix the wood with the Fixture body.

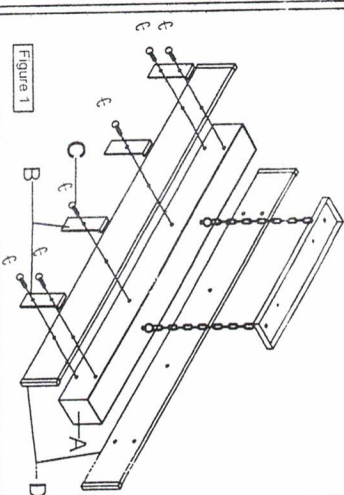

## (Step 1 Continued)

A. Line up the holes on the D wood panel to the holes on the A fixture body side. Put the B L metal panel on the wood panel then line up the holes. Thread the C screw with cap into the holes. Hand tighten until snug.

STEP 2 - Attach Mounting Screws, Lock Washers and Hex Nuts to Crossbar

A. Line up a set of holes on the Crossbar (EE) and Holes on the ceiling canopy. Thread Mounting Screws (DD) into the holes on the Crossbar (EE). Pass Lock Washers and thread Hex Nuts onto the Mounting Screws (DD). Hand tighten until snug.

Figure 2

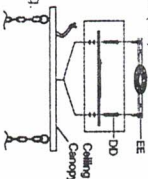

## STEP 3 - Attach Crossbar to Outlet Box

A. Pass the supply wires through the Crossbar (EE). Attach the Crossbar (EE) to the Outlet Box (CC) with the head of the Green Ground Screw facing you. Secure it with Outlet Box Screws (not included). Tighten until snug.

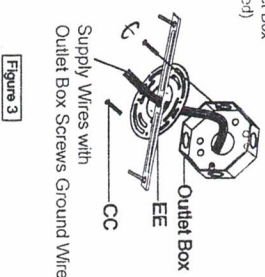

Figure 3

## STEP 4 - Fit Ceiling Canopy to Crossbar Assembly

A. Fit the ceiling canopy to Mounting Screws (DD) and secure with Mounting Balls (AA). Note: The ceiling canopy should be snug against the ceiling and the Mounting Balls (AA). If not, adjust the length of the Mounting Screws (DD) by unscrewing the Hex Nut and Lock Washer and then screwing Mounting Screws (DD) in or out of the Crossbar (EE) until the correct length is achieved. Once the ceiling canopy is secure, remove the Mounting Ball (AA) and ceiling canopy and proceed to Step 5.

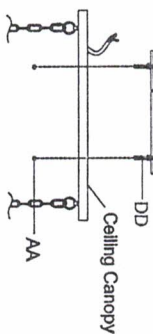

Figure 4

## STEP 5 - Wire Connections

A. Use standard wire connectors to make all wire connections. Twist connectors until wires are tightly joined together. Wrap each connection with approved electrical tape and carefully stuff all the connected wires into the Outlet Box.

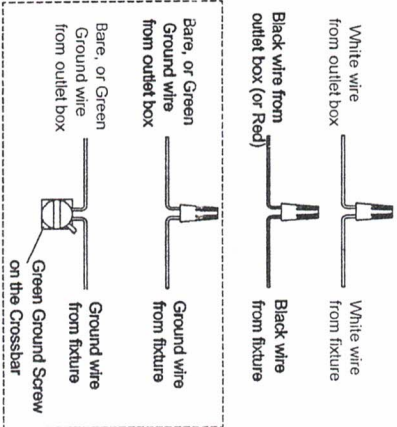

Figure 5

## STEP 6 - Install Ceiling Canopy to Ceiling

A. Carefully tuck all wires into the outlet box and position the ceiling canopy of the Fixture Body (A) over the outlet box. Align the holes in the ceiling canopy with the Mounting Screws (DD). Secure with Mounting Balls (AA) and hand tighten until snug.

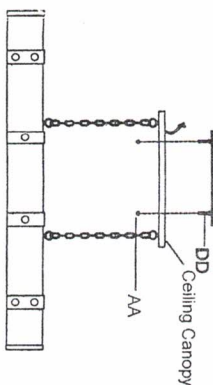

Figure 6

## STEP 7 - Install Bulbs.

A. Take off the Housing from the Fixture body A. Be careful do not pull too much and cut the hands. Then assemble the the GU10 bulb into the socket. Press the both side springs on the housing and put the housing back into the Fixture Body A.

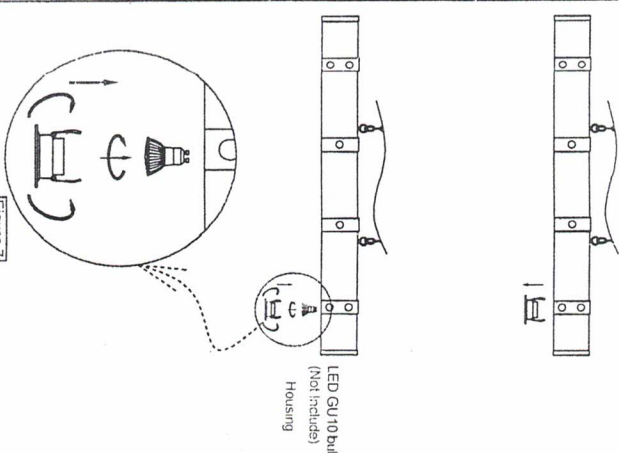

Figure 7