

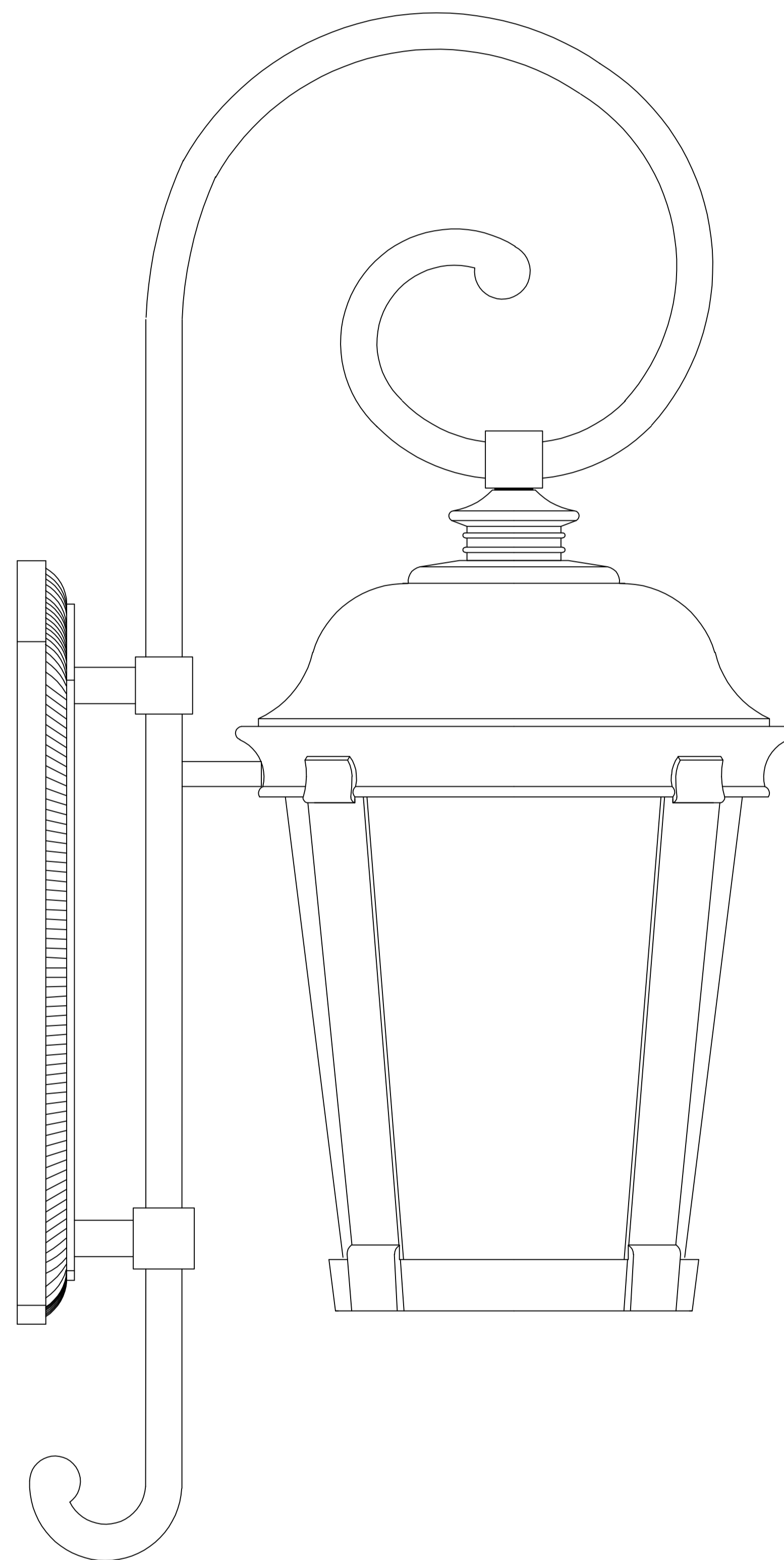

PRODUCT NAME: Dover  
ITEM NUMBER: 56095

Please consult your electrician for hanging fixture and wiring.



To prevent water intrusion, caulk around back-plate where fixture meets the wall using outdoor silicone sealant. Leave a small gap at the bottom to allow moisture to exit.

Bulb(included): 1×12W E26 LED

MADE IN CHINA



**PRODUCT NAME:** Dover  
**ITEM NUMBER:** 56095

**IMPORTANT:** Turn off the power at the main fuse or circuit breaker box before starting installation.

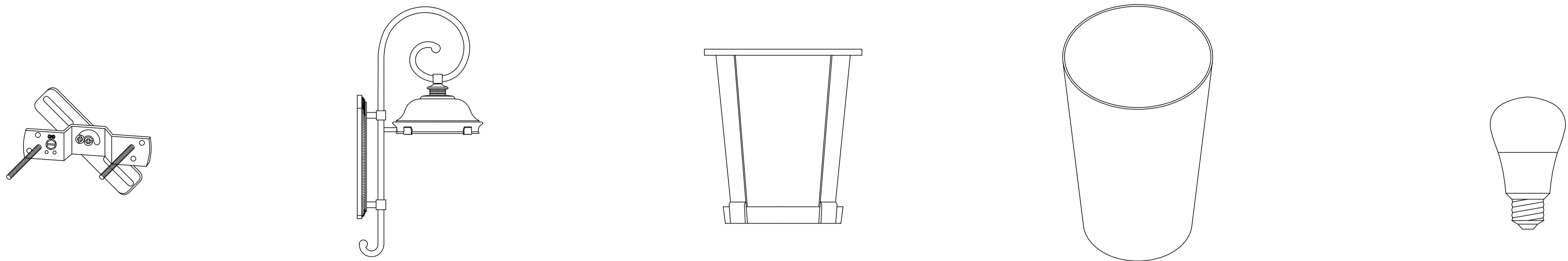

**Bracket (A)      Fixture (B)      Cage (C)      Glass (D)      E26 LED Bulb (E)**

**Locate all hardware & components before discarding packaging**

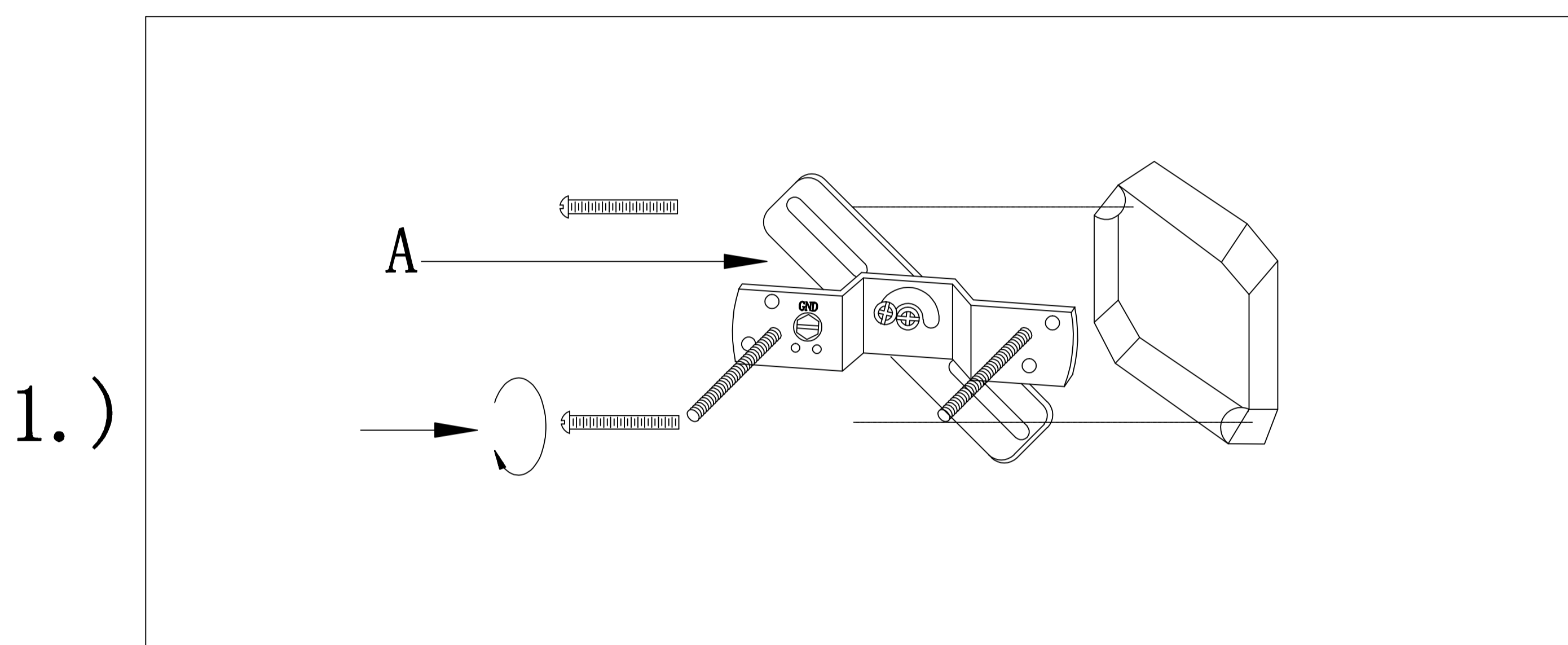

1.)

**Step.1:** Remove mounting bracket from fixture(B) and install to electrical box. then wire fixture to wires in outlet box. Copper wire is for Ground.

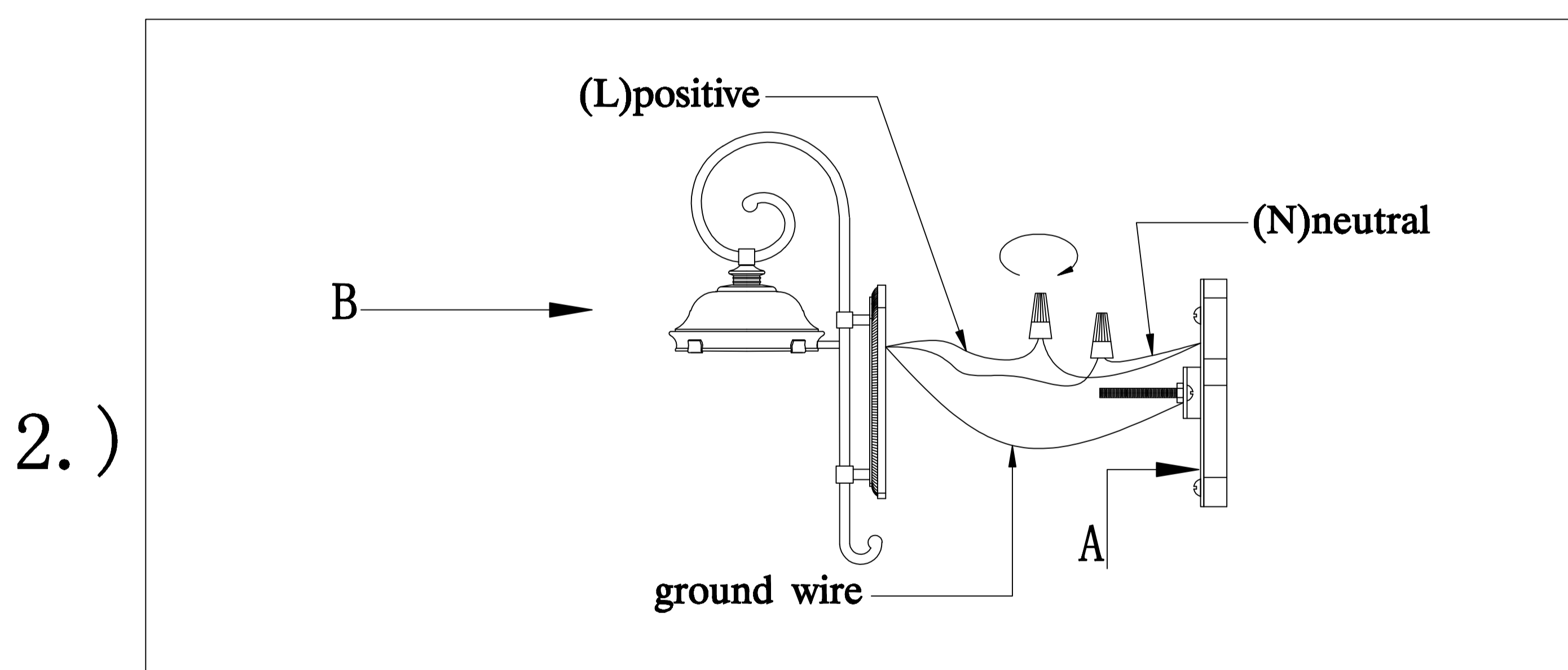

2.)

**Step.2:** Attach back plate to mounting bracket and tighten ball nuts so fixture meets wall. Caulk fixture where back plate meets the wall with silicone sealant.

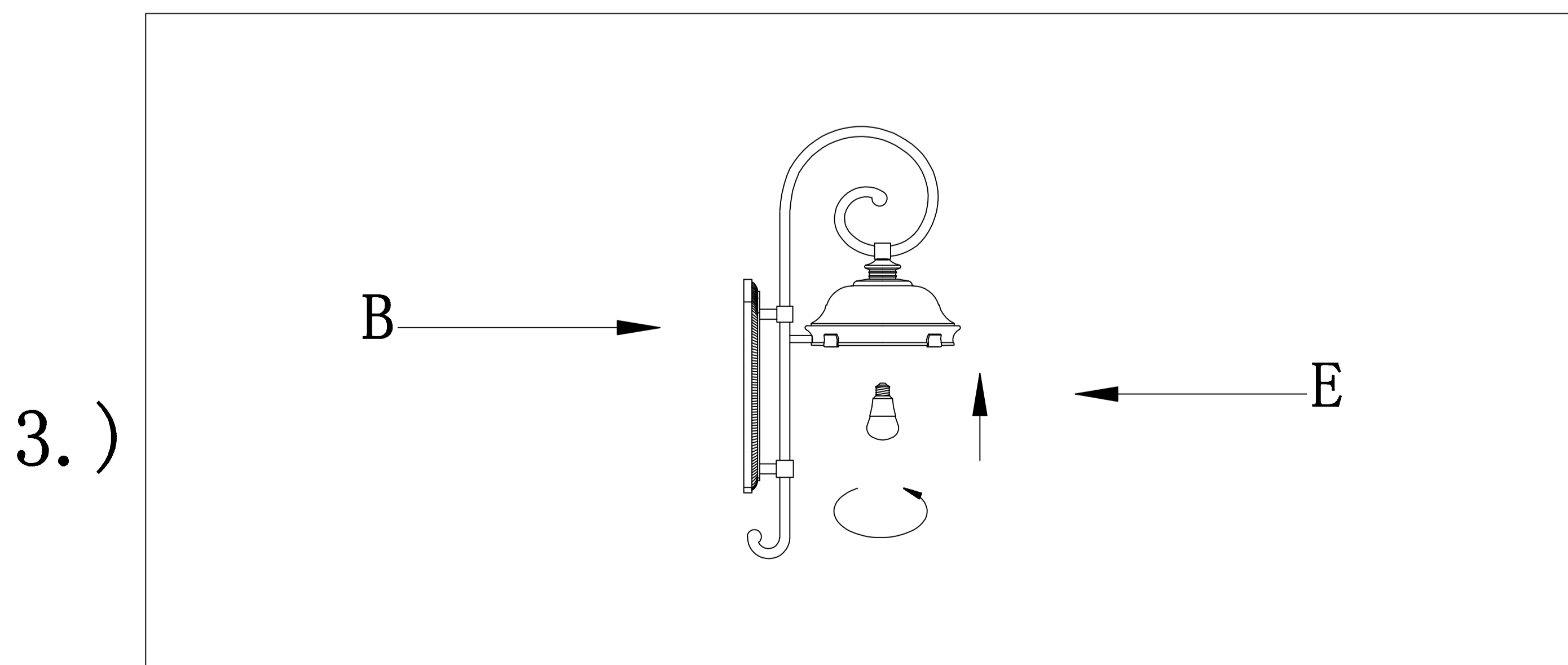

3.)

**Step.3:** Install E26 LED bulb(E)

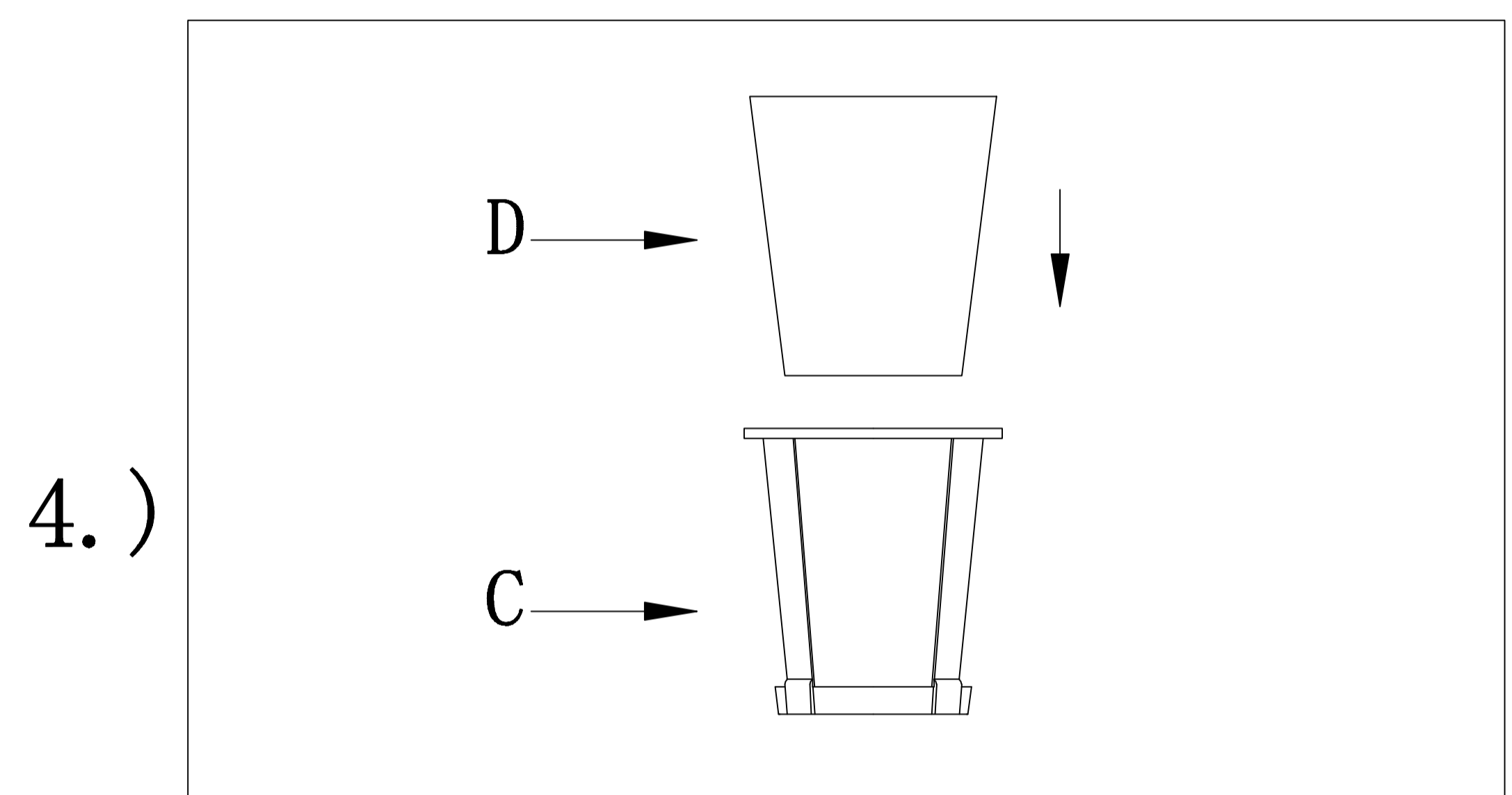

4.)

**Step.4:**Install the glass (D) into the cage(C)

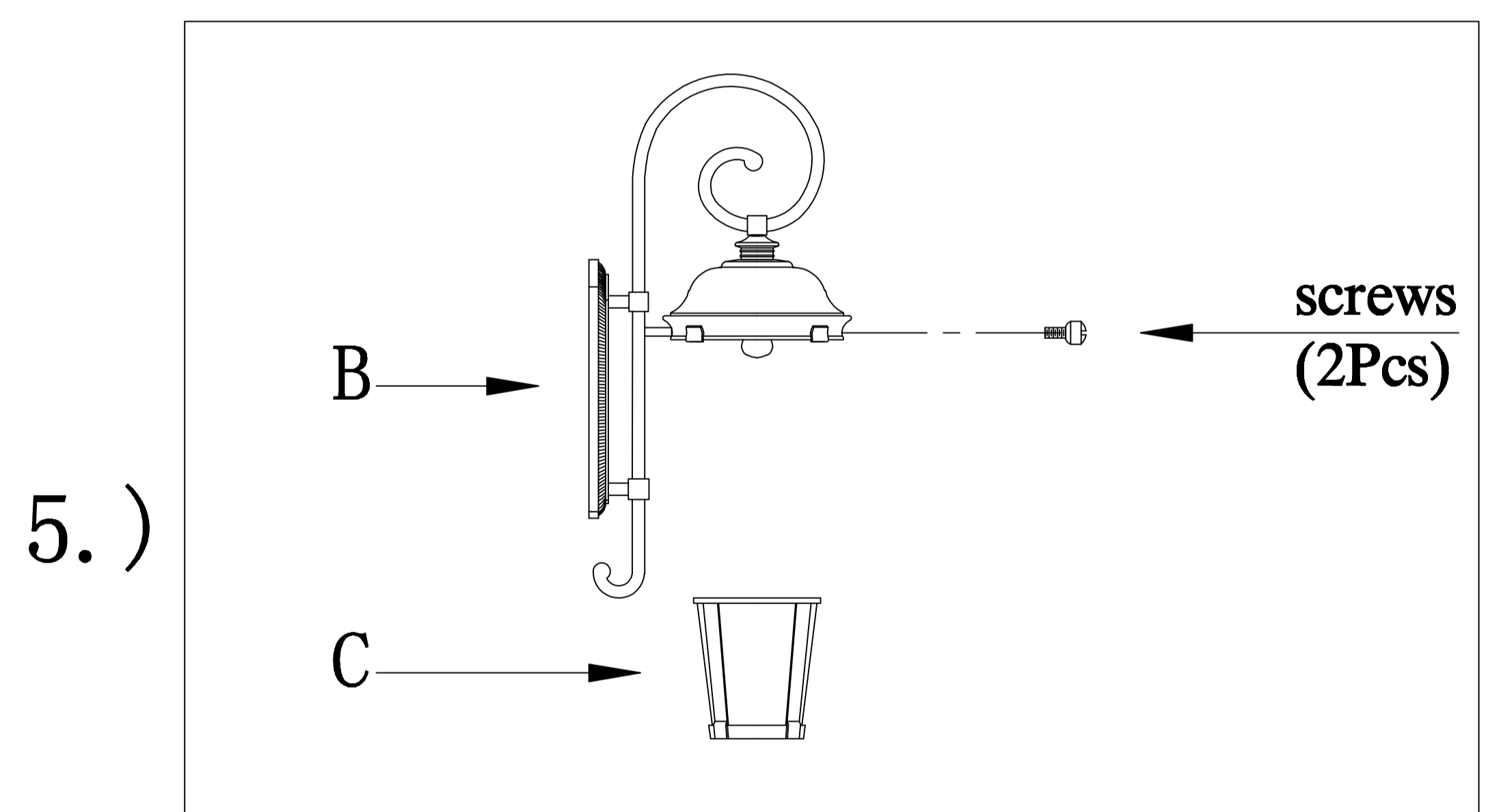

5.)

**Step.5:** Install cage(C) to fixture , using screws .

**Cleaning & Care:**  
 Clean with soft cloth and a mild detergent.  
 Do not use abrasive cleaner.

**MADE IN CHINA**