

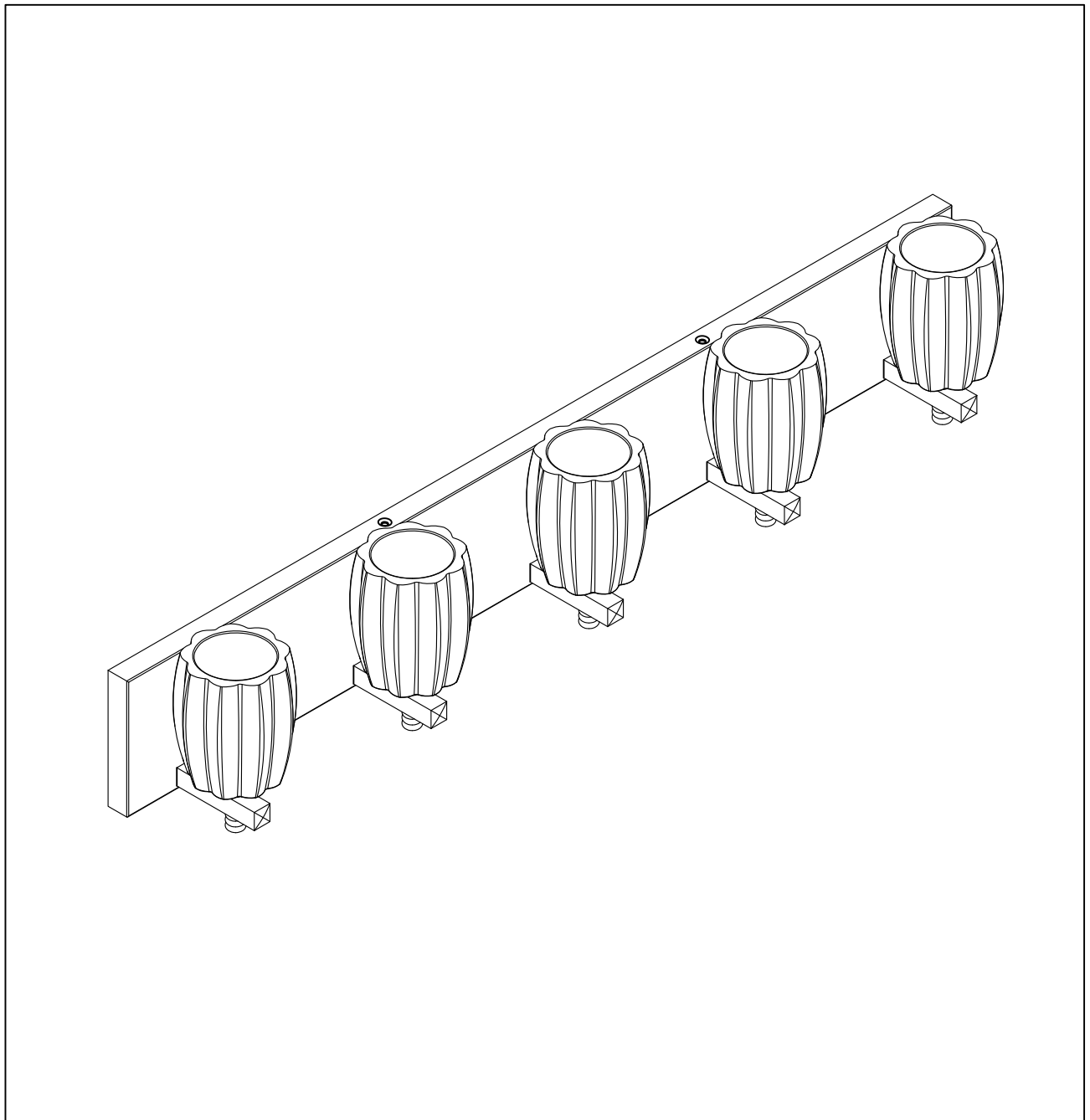

PRODUCT NAME: Bravado
ITEM NUMBER: 9045CIPC /9045CIGO

Please consult your electrician for hanging fixture and wiring.



Bulbs (Included): 5 x 4W G9 LED

IMPORTANT: Turn off the power at the main fuse or circuit breaker box before starting installation

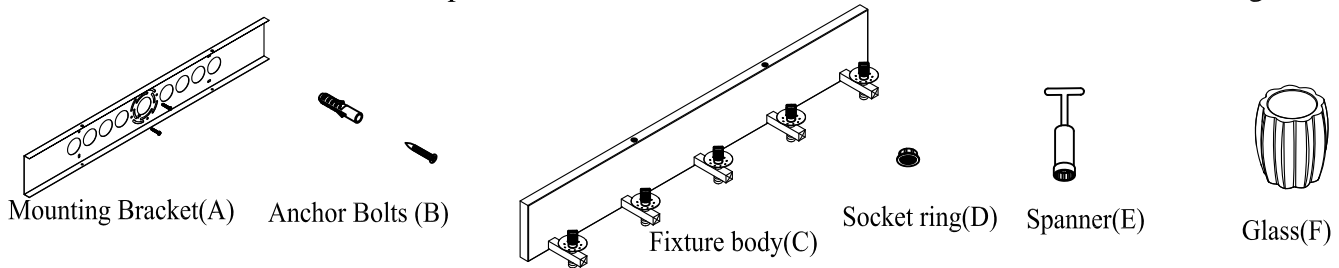

Locate all hardware & components before discarding packaging

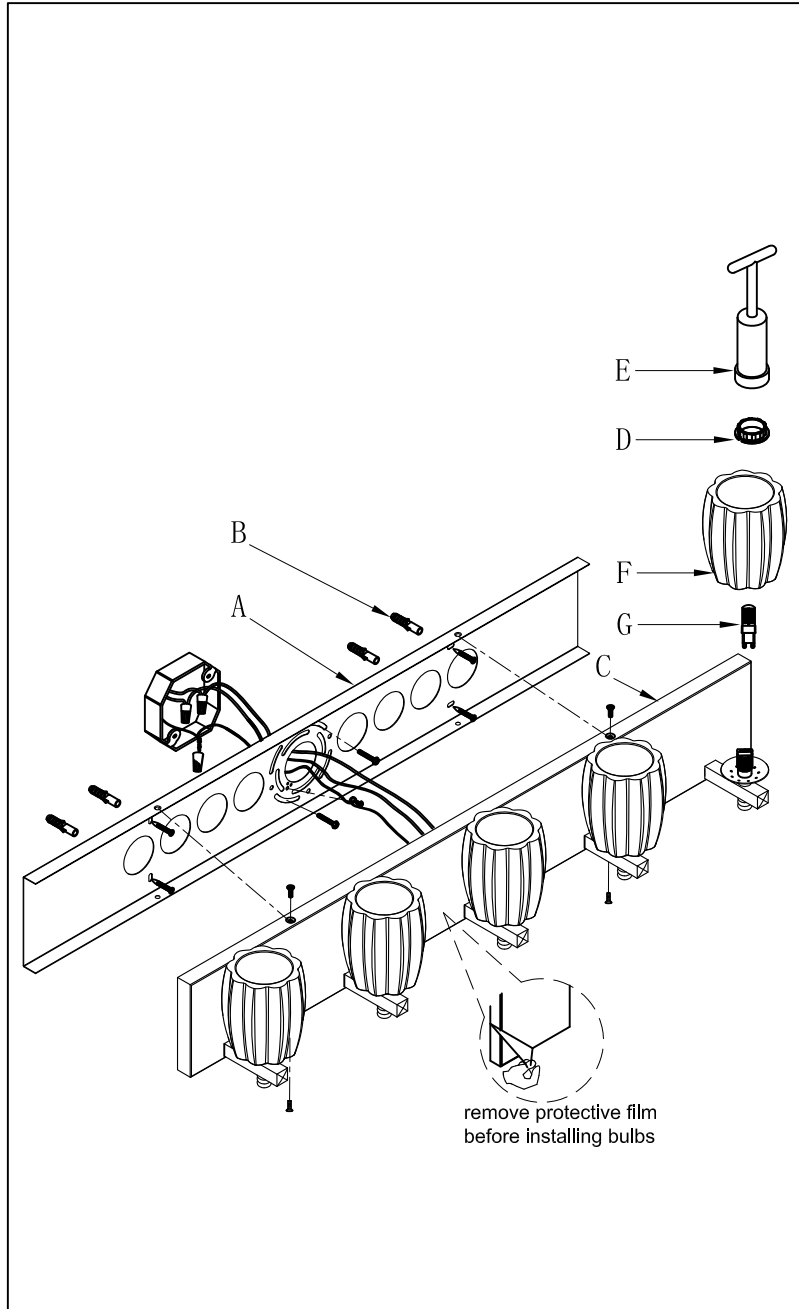

1.)

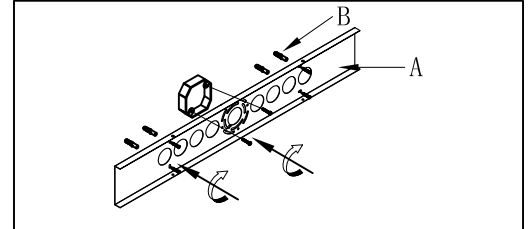

Step.1: Place the mounting bracket(A) up against the ceiling, and over the outlet box in the desired position. Drill holes, insert anchor bolts(B) into the holes until they are tightened together.

2.)

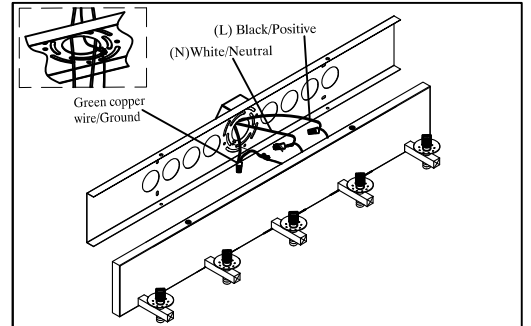

Step.2: Wire fixture to wires in outlet box. Green copper wire is for ground. And carefully position all wires inside the outlet box.

3.)

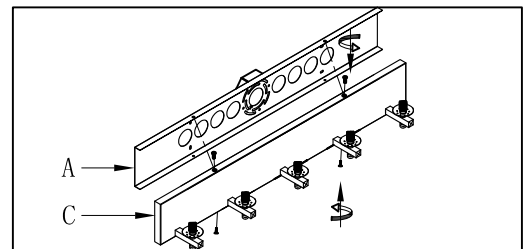

Step.3: Place the fixture body(C) against mounting bracket, Align the two holes of the mounting bracket and fixture body, then tighten the screws.

4.)

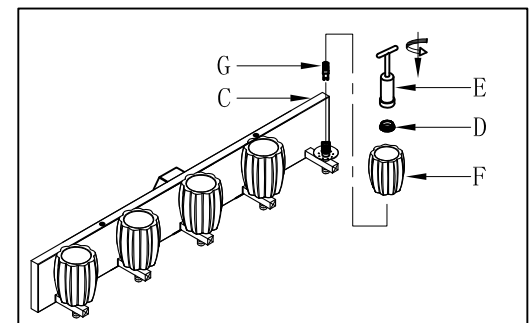

Step.4: Install G9 LED bulb(G) into socket, Position Glass(F) onto the socket of fixture body(C), then secure with socket ring(D) with Glass (F) onto Fixture body(C) by using spanner(E).

Cleaning & Care:
Clean with soft cloth and a mild detergent.
Do not use abrasive cleaner.