

shown in Gloss White
with Gloss White blades



Eliza-H *Geometry in Motion*

Designed in 2014

Designed by Chicago architect Stephen Katz in 2014, the Eliza-H ceiling-mount fan blends a beautiful technically derived form with superior function and movement. The unique blade shape is designed to maximize air movement at the outer edge of the blade. The result is more efficient air velocity rings, less blade drag and greater motor optimization. Equally important is Eliza-H's stationary visual statement which combines modern utility with minimalist geometry. Constructed of cast aluminum and heavy stamped steel, the Eliza-H has a limited lifetime warranty.

Product Features



DC
Motor



Damp
Location



Silent



Remote
Control



Wall
Control



Unpack
Shipping

shown in Gloss White
with Gloss White blades



shown in Matte Black
with Brushed Nickel blades



shown in
Gloss White
with Old Oak blades



shown in Matte Black
with Matte Black blades



shown in
Brushed Nickel
with Walnut blades



shown in Brushed Nickel
with Barn Wood blades



shown in
Matte Black with
Gray Ash blades



ELIZA-H

FINISH AND BLADE OPTIONS

SKU#	EKH-XX-XX (Model+Finish+Blade)	
Standard Finishes	Brushed Nickel Gloss White Matte Black	BN WH BK
Blade Finish	Barn Wood Brushed Nickel Gloss White Gray Ash Matte Black Old Oak Walnut	BW BN WH GA BK OO WN

TECHNICAL SPECS

Fan Diameter	56 inches / 142 cm
Blade Material	ABS
Overall Drop	10 inches / 25 cm
Fan Weight	14 lbs
Voltage	110 or 220
Motor Type	DC
Environment	Damp locations for all finishes Neither coastal, saltwater nor chlorine compatible
Ambience	Silent
Safety Certification	ETL / CETL
Warranty	Limited Lifetime

NEW JAN 21, 2020 DOE MOTOR EFFICIENCY DATA

RPM (Low / High)	52 / 175
CFM (Low / High)	1123 / 4034
Watts (High)	33.49
CFM/Watt (High)	122
Blade Pitch	27°

STANDARD EQUIPMENT

Black 6-speed RF
remote control
with reverse



White wireless
Decora-style,
6-speed, wall
control with
reverse



NOTE: Only compatible with included controllers.

Blade Options

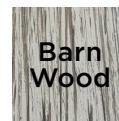

Barn
Wood

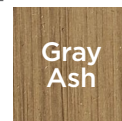

Gray
Ash

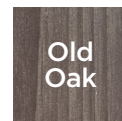

Old
Oak



Walnut



Brushed
Nickel

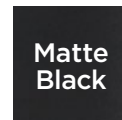

Matte
Black



Gloss
White

Eliza-H

TECHNICAL SPECIFICATIONS

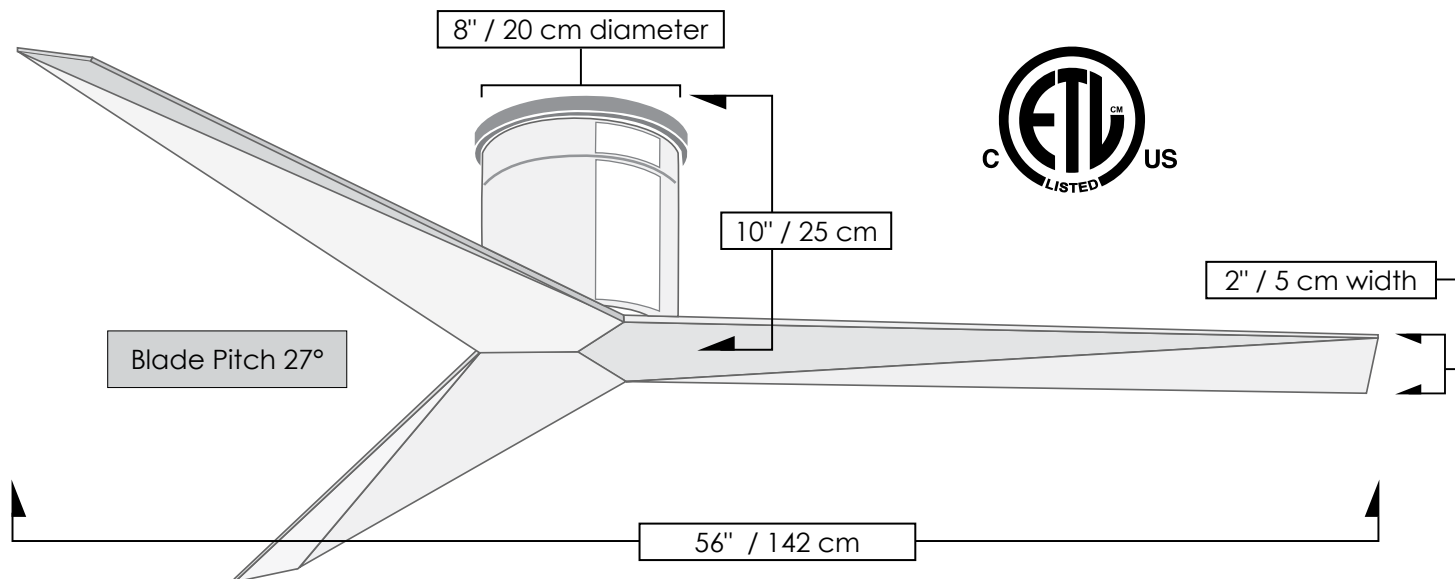

CEILING PITCH TABLE

0/12	0 degrees
1/12	4.76 degrees
2/12	9.46 degrees
3/12	14.04 degrees
4/12	18.43 degrees
5/12	22.62 degrees
6/12	26.57 degrees
7/12	30.26 degrees
8/12	33.69 degrees
9/12	36.87 degrees
10/12	39.81 degrees
11/12	42.51 degrees

CEILING HEIGHT TABLE

Suitable for ceiling heights 7' 10" or greater

Matthews Fan Company

1881 Industrial Drive
Libertyville, IL 60048
Tele: 847.680.9043
Fax: 847.680.8140
www.matthewsfanco.com

© 2023 Matthews Fan Company. All rights reserved.

