

Installation Guide

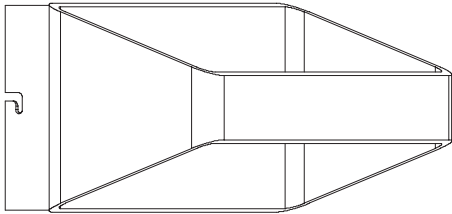

VONN Lighting
Model: VMW15810



LED INFO & WARNINGS

- Please read and comprehend the entire manual before attempting to assemble, operate, or install the product.
- Make sure that you have all necessary parts by checking the parts list. If any part is missing or damaged, please contact **VONN Lighting Customer Service at 888-604-8666** for a replacement.
- All parts must be used as indicated in these instructions. Do not substitute any parts, leave parts out, or use any parts that are worn or broken.
- Inspect the LED fixture prior to installation to make sure that it has not been damaged during shipping.
- Please handle the LED light with care when unpacking. Do not apply pressure to the LED's, do not open any factory sealed compartments, and do not touch the LEDs with your hands.

VONN highly recommends to use a qualified, licensed electrician to install the fixture.

- VONN recommends to install the fixture on its own independent circuit. Do not install the fixture on the same circuit with other appliances, or HVAC systems.
- Do not remove or replace VONN manufactured driver that is provided with the fixture.
- VONN recommends **ELV (Electric Low Voltage)** type dimmers for this fixture.
- Shut "OFF" the electricity at main fuse box.
- Place the wall switch in the "OFF" position of the room you are installing the fixture.

Parts List

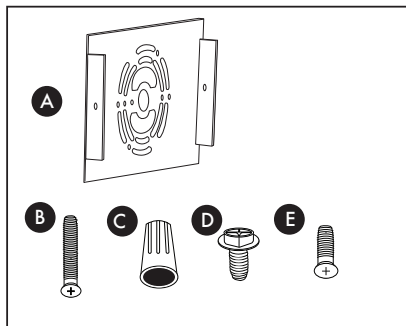

- A. Mounting Bracket
- B. Outlet Screws x 3
- C. Wire Connectors x 3
- D. Ground Screw x 1
- E. Canopy Screws x 2

Circuit Box

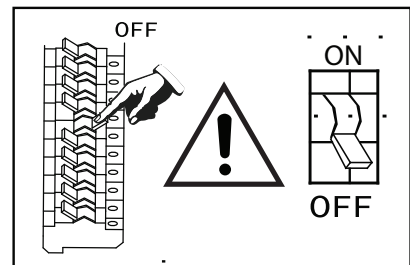

Tools You May Need

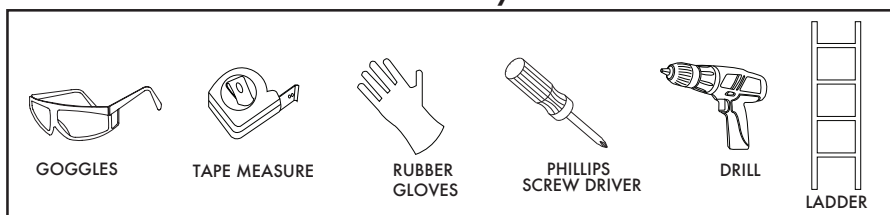

Fixture Diagram

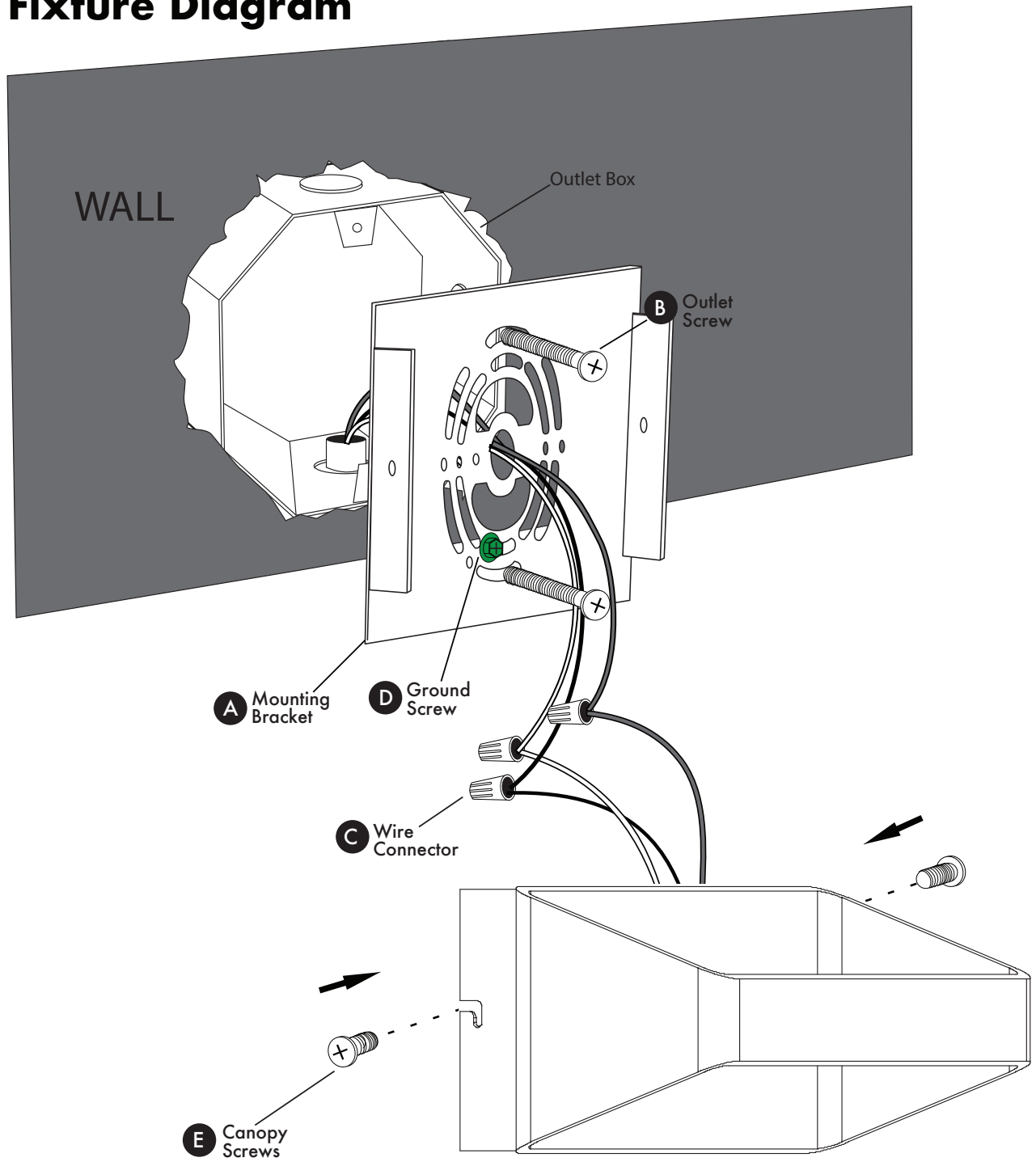

Step 1. Install Mounting Bracket

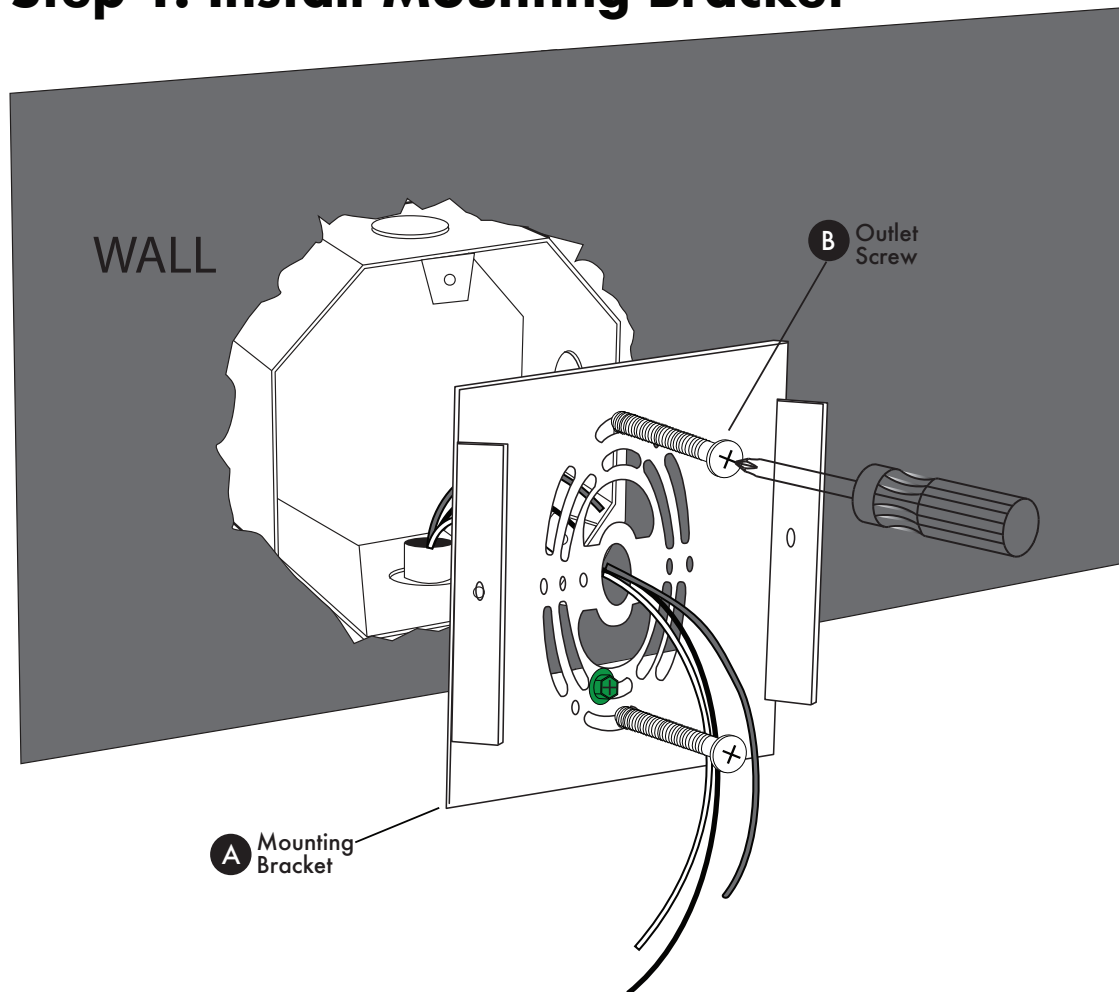

Align mounting bracket (A) with outlet box and secure with outlet screws (B).

Step 2. Connect Wires

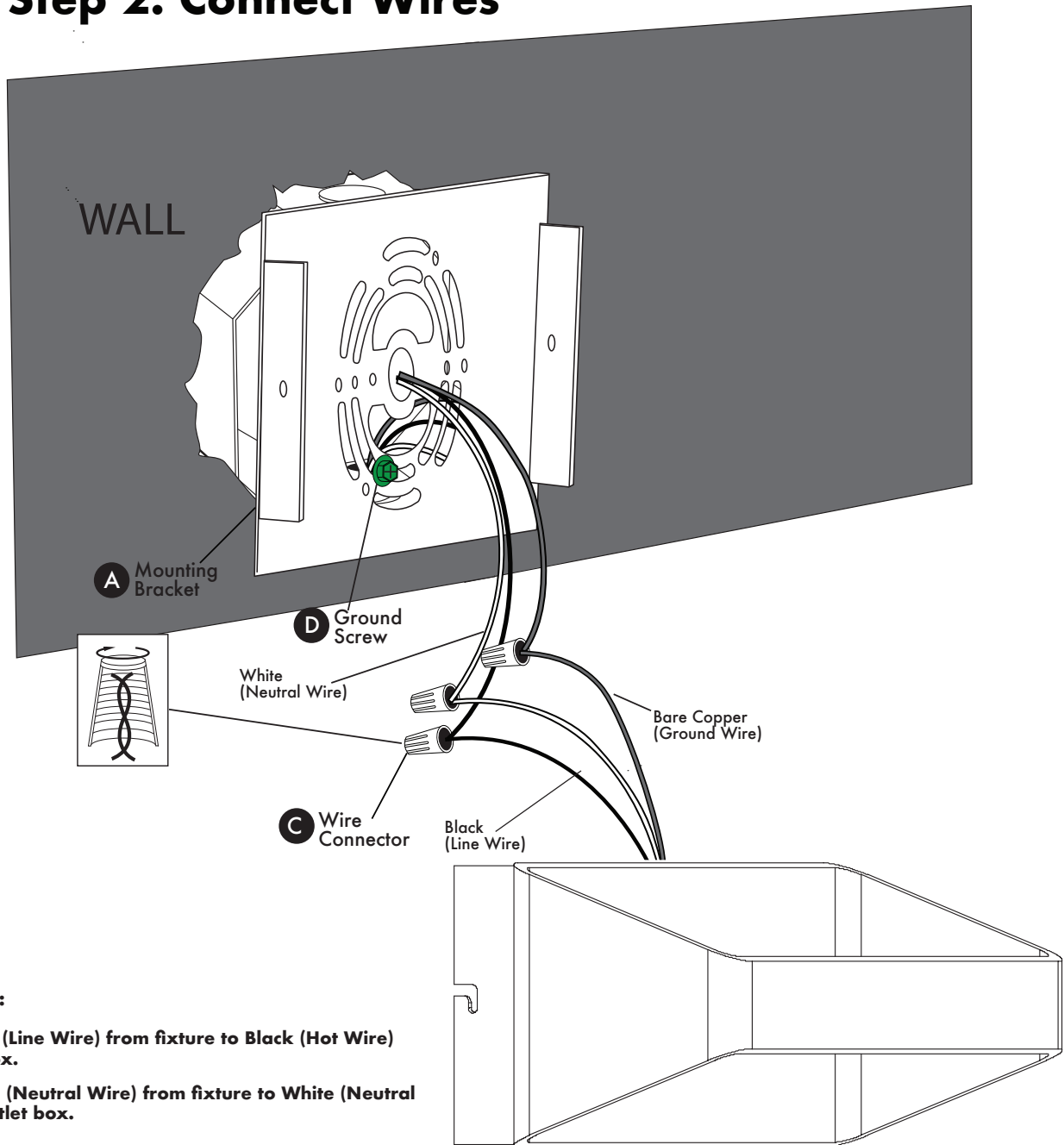

Supply Wires:

Connect Black (Line Wire) from fixture to Black (Hot Wire) from outlet box.

Connect White (Neutral Wire) from fixture to White (Neutral Wire) from outlet box.

Ground Wires:

Connect Bare Copper (Ground Wire) from fixture to Green or Bare Copper (Ground Wire) from outlet box.

Twist wires together clockwise and secure with wire connector (C).

Installer Tip (1): If ground wire is not available in outlet box, then secure Bare Copper (Ground Wire) from fixture to ground screw (D) on mounting bracket (A).

Installer Tip (2): Supply wires can be either tucked into outlet box or fixture canopy.

Step 3. Mount Fixture

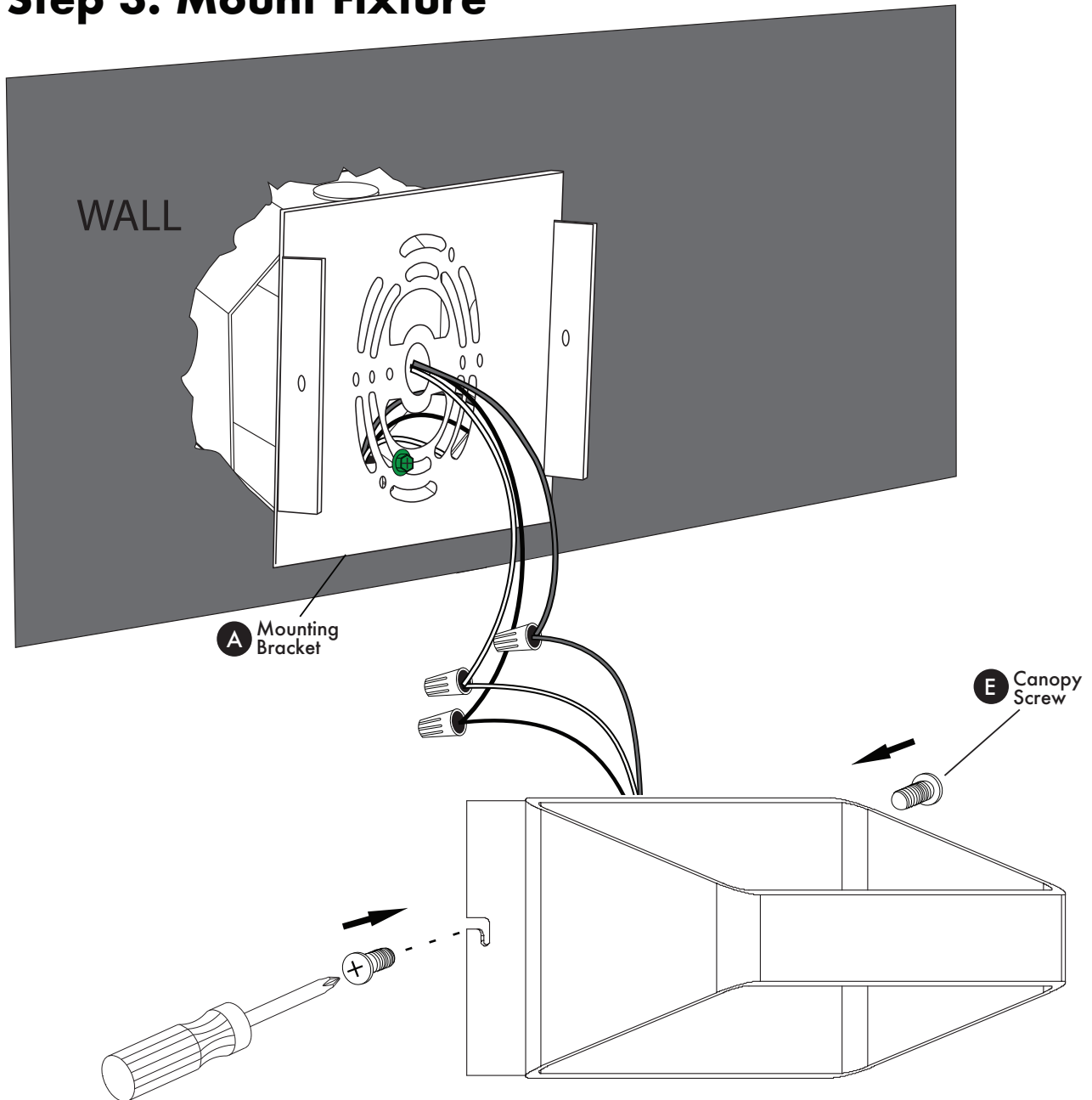

Attach fixture to mounting bracket (A). Secure with canopy screws (E). Tighten with Phillips head screwdriver.

Step 4. Turn Power ON

Turn electricity "ON" at main fuse box.

Place the recommended ELV type dimmer switch in the "ON" position to test the fixture.

Circuit Box

