

Assembly Instructions

MODEL#:86122ABZ

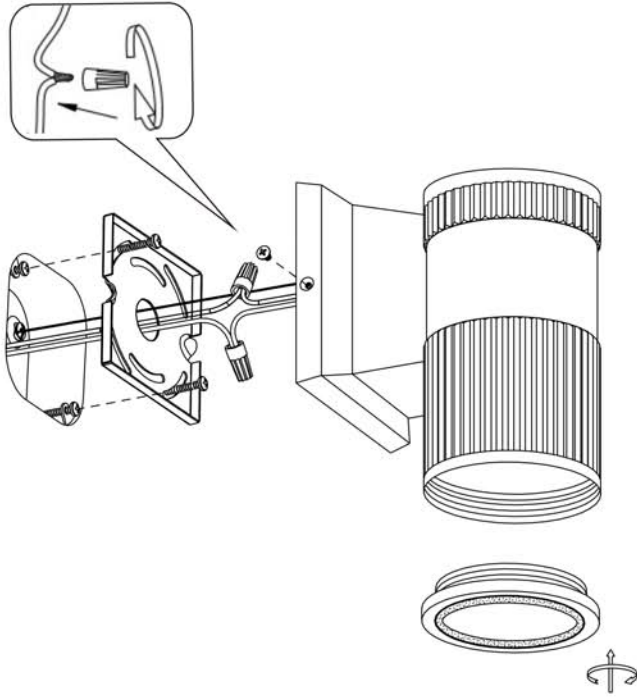

Warning

1. Make sure that the power is switch off at the electricity mains supply before commencing work.
2. To clean your fixture, we recommend that you use a damp soft cloth to wipe off dust. **DO NOT USE** abrasive pads or cleaning materials.
3. Lamp shade only allows disassembling in replace light source.

Fixing Instructions

1. Remove the back plate from the canopy.
2. Attach the back plate to the junction box.
3. Use the supplied wire connectors, connect wire to the light fitting. Ensure that wires are secure and that no bare wire is exposed.
4. Place the fixture over the back plate, and attach with two screws to hold the fixture in place.

Light source

1 x 10W LED 3000K,700 Lumen