



ITEM#: 1505CH/10

⚠ WARNING

DISCONNECT POWER AT THE MAIN FUSE BOX BEFORE INSTALLATION.

CONSULT A QUALIFIED ELECTRICIAN BEFORE INSTALLATION.

PREPARATION

Before assembly, be sure to remove all parts and part packages from box. If anything is missing, please contact the store or internet vendor from which product was purchased.

INSTALLATION

- ① Determine proper length of chain. After removing or adding links to the desired length, attach end of chain to fixture frame.
- ② Connect wiring together and mount fixture to ceiling. (See other side for wiring and mounting instructions).
- ③ Unfold arms spacing them evenly.
- ④ Slip candle covers over sockets.
- ⑤ Install light bulbs. Use 60 watt max candelabra base bulbs (not included).
- ⑥

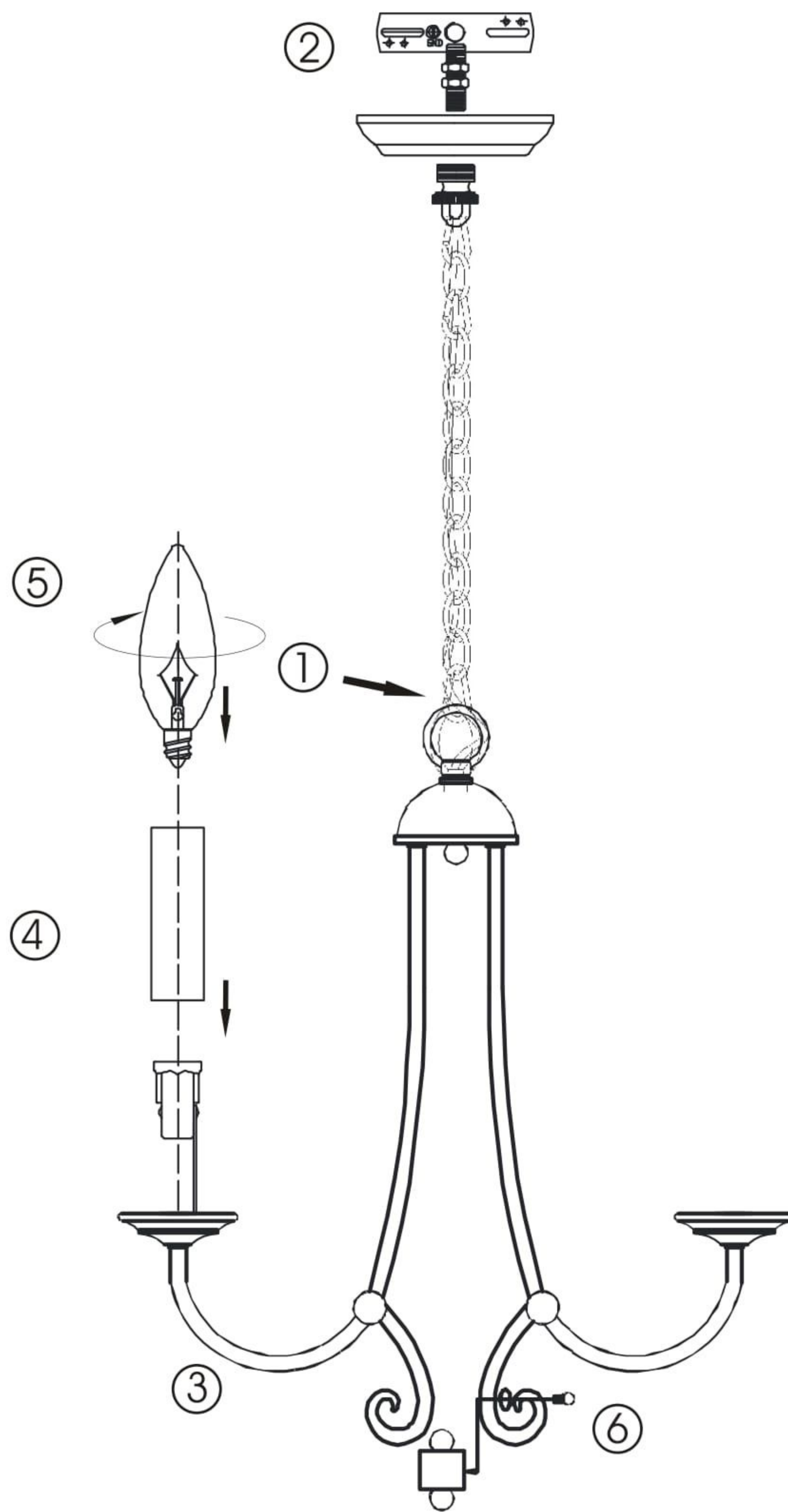

WIRING AND MOUNTING INSTRUCTIONS

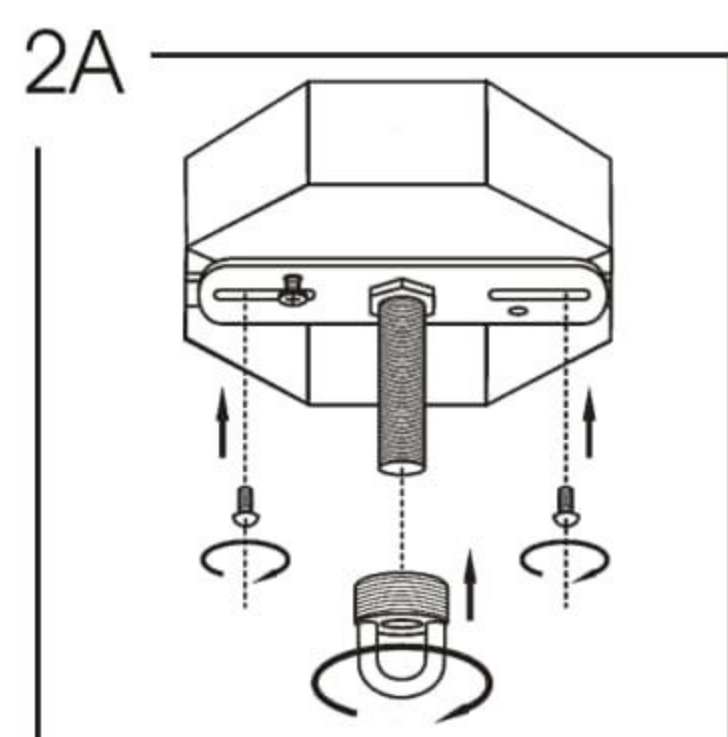

Screw crossbar assembly into junction box using outlet box screws. Thread screw collar onto threads of crossbar assembly.

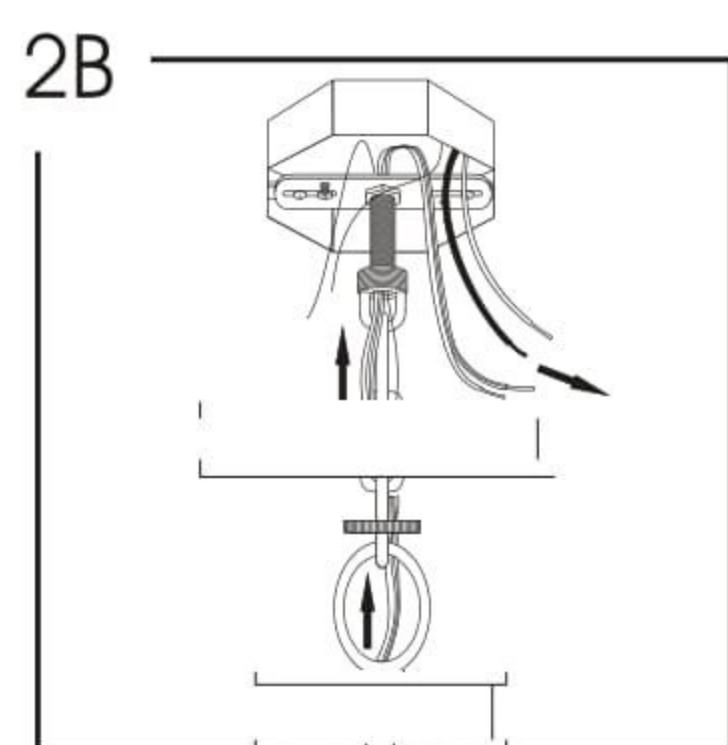

Slip screw collar ring and canopy onto chain, and hang fixture onto screw collar using an open link of chain. Close link. Thread wire and ground cable through screw collar ring, canopy, chain, screw collar, and through threaded tube on crossbar assembly. Pull wires through.

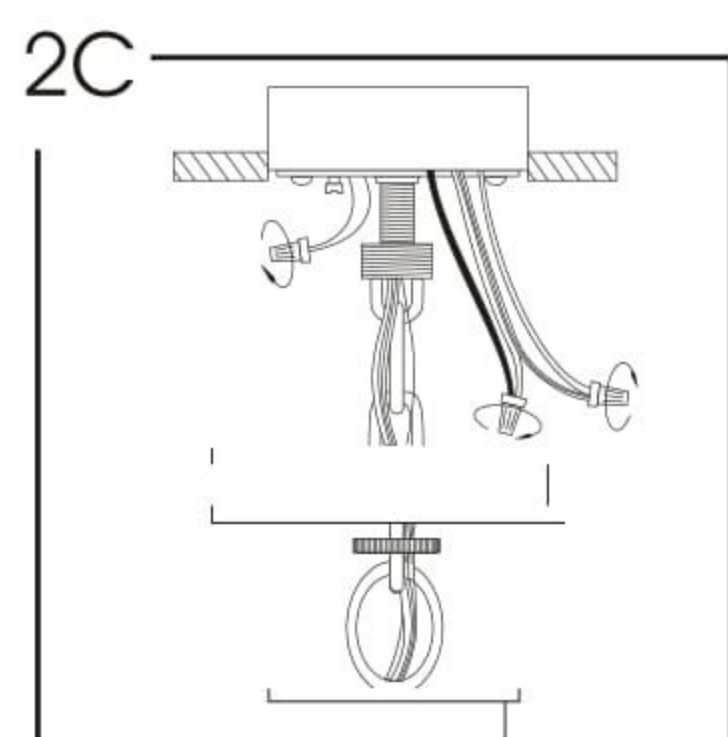

Strip 3/4" of insulation from wire ends. Connect house ground wire to fixture ground wire. Twist wires together using wire nut. Connect the black house wire to the smooth or black fixture wire. Twist wires together using wire nut. Connect the white house wire to the ribbed or white fixture wire. Twist wires together using wire nut.

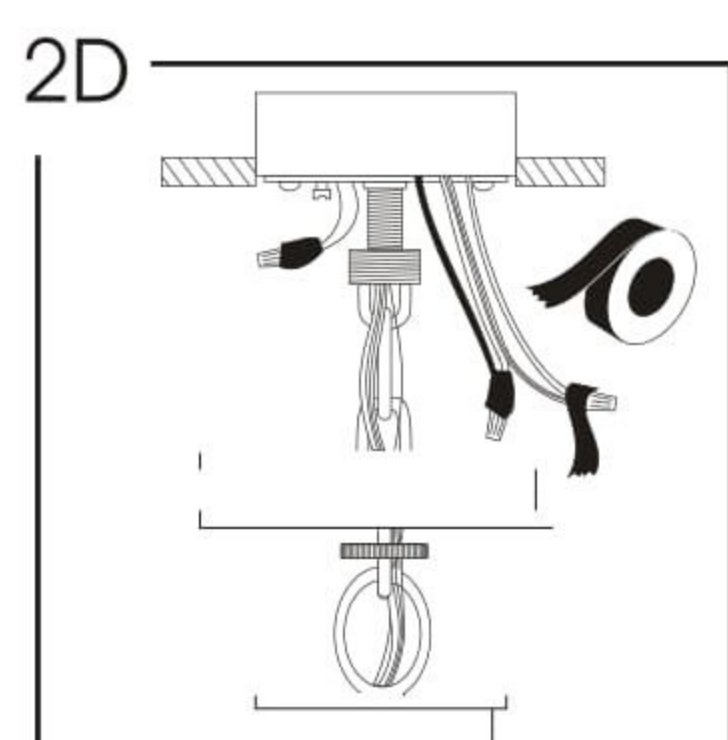

Tape wires and wire nuts together using electrical tape.

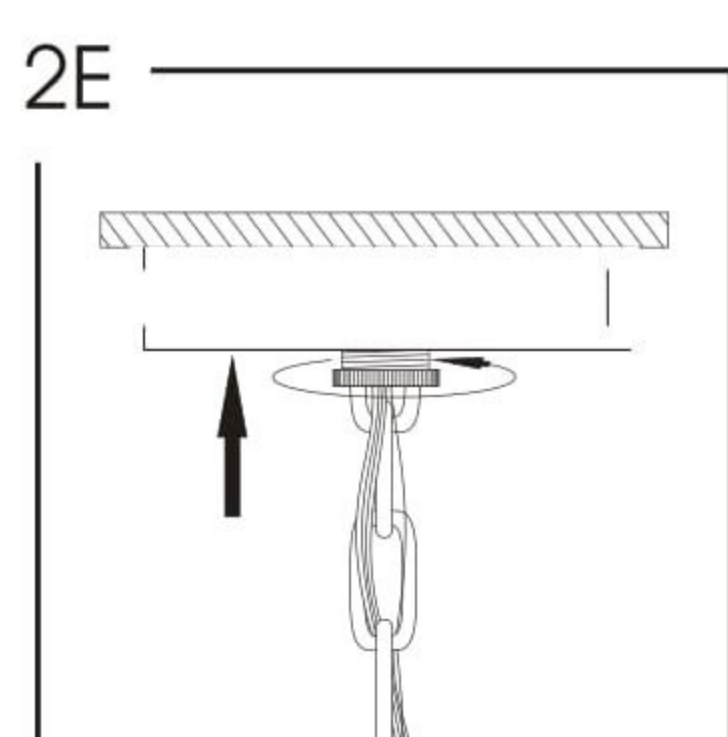

Carefully tuck wires into junction box and secure canopy to ceiling using screw collar ring.
(Continue with step 3 of installation on other side.)