

Tools Required

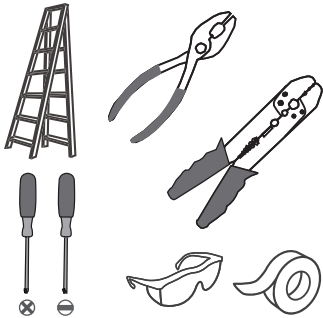

Light Source

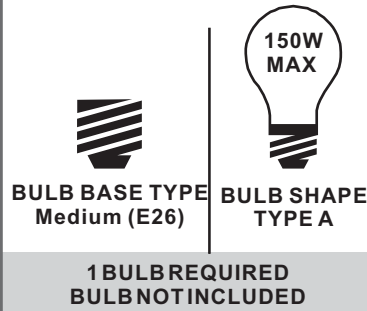

Warnings and Cautions

Turn off the electricity at the circuit breaker before installation. Consult a licensed electrician if in doubt about installation.

Turn off power to the fixture and allow the bulbs to cool before replacing.

Package Contents

Preparation: Identify and inspect all parts before beginning the installation.

Missing or damaged parts? Contact your original place of purchase.

PARTS BAG

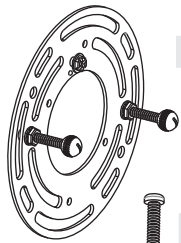

A Crossbar Assembly x 1

B Alternate Mounting Screw x 2



C Outlet Box Screw x 2



D Wire Connector x 3

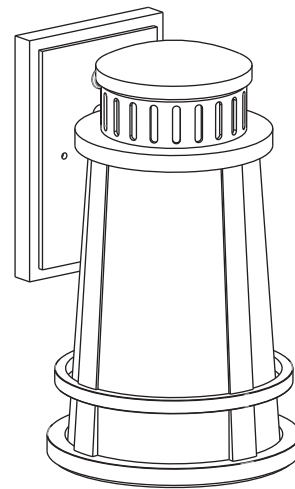

E Fixture Body x 1

Table of Contents

Remove Styrofoam	Alternate Mounting Screw	Crossbar Assembly	Wiring
STEP 1	STEP 2	STEP 3	STEP 4
STEP 5	STEP 6	STEP 7	STEP 8
Fixture Body	Bulb	Caulk	Replace Glass

STEP 1

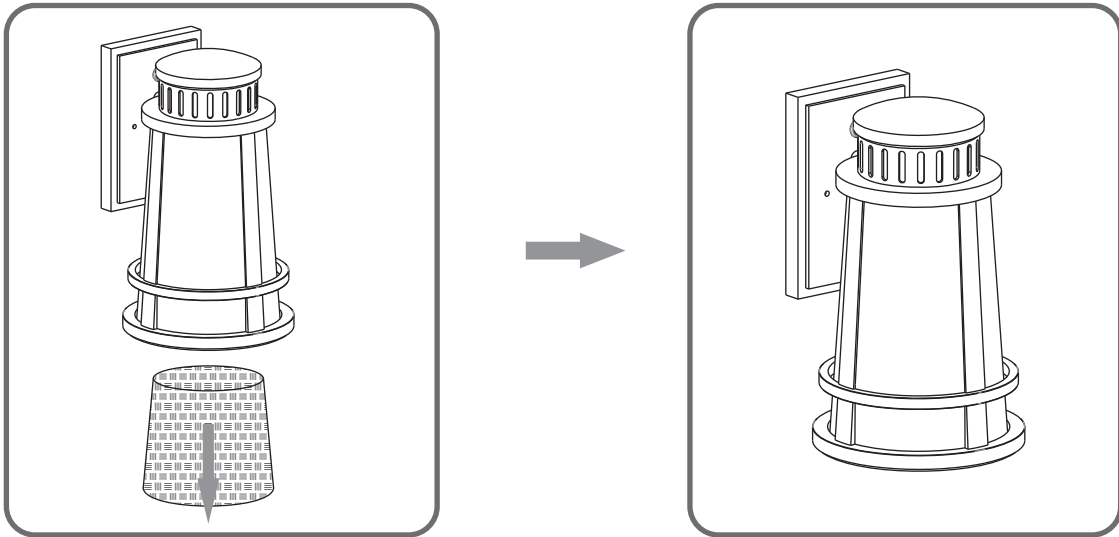

STEP 2

OPTION 1

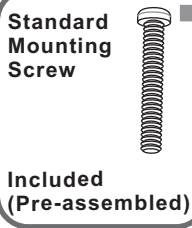

skip to next page

1 2 3

Steps 1-3 to remove standard mounting screws

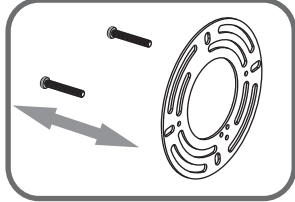
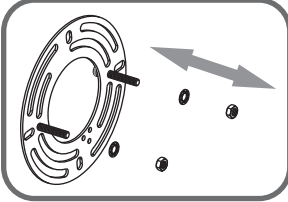
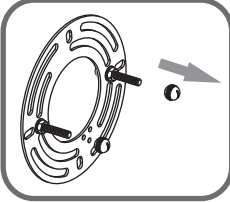

OPTION 2



Steps 4-6 to reassemble with alternate mounting screws

6

5

STEP 3

1

2

3

Step 1
Install crossbar assembly

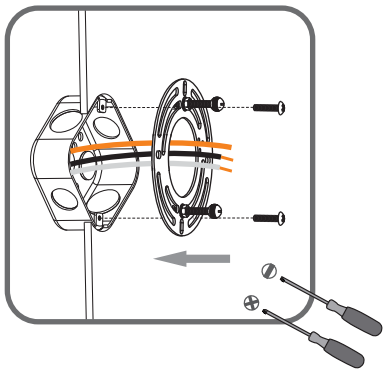

Step 2 - 3
Test fitting backplate to mounting screws

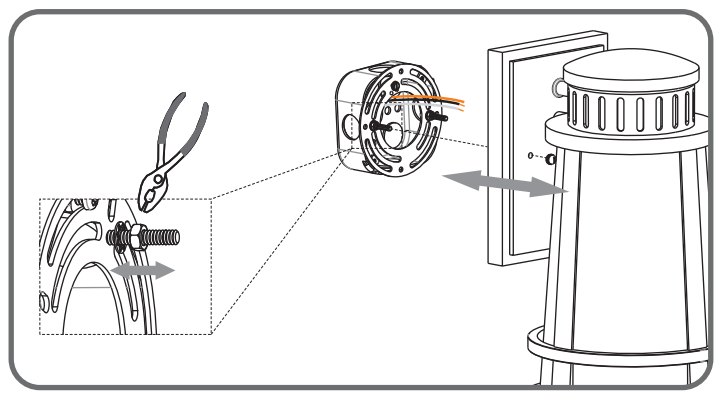
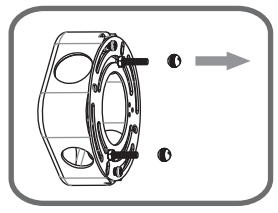

STEP 4

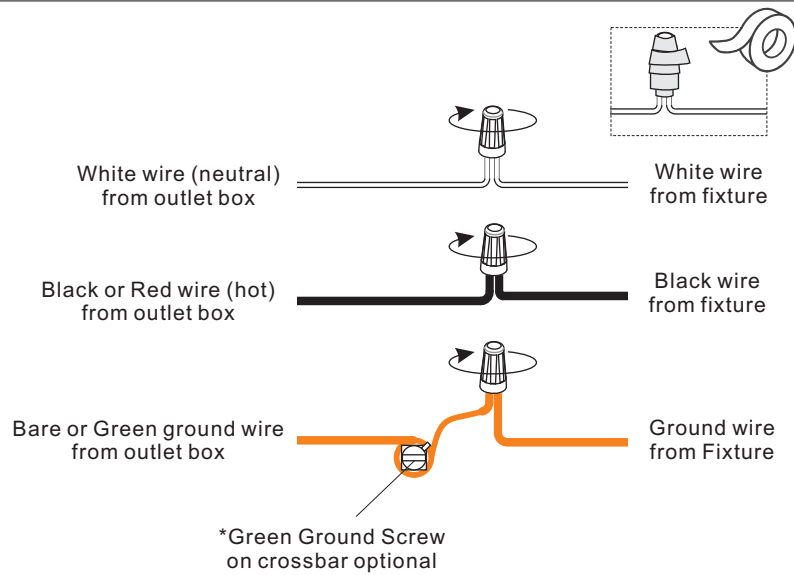

STEP 5

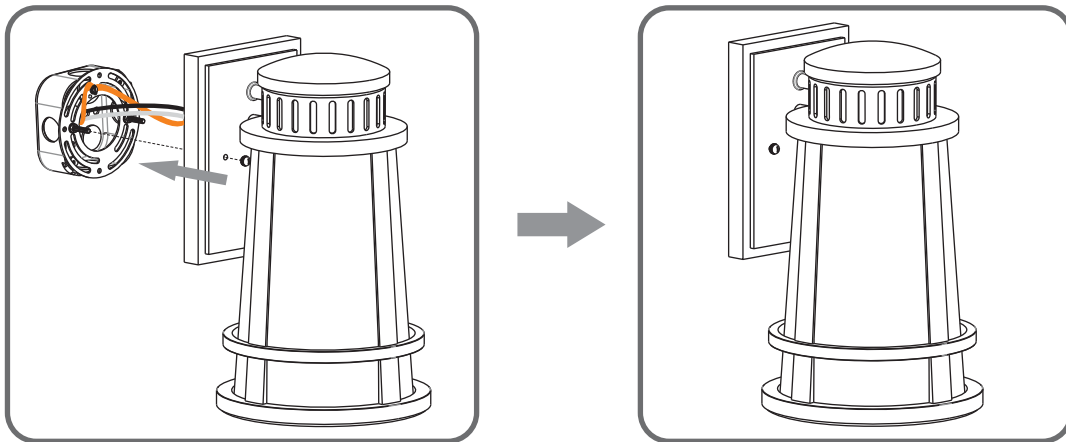

STEP 6

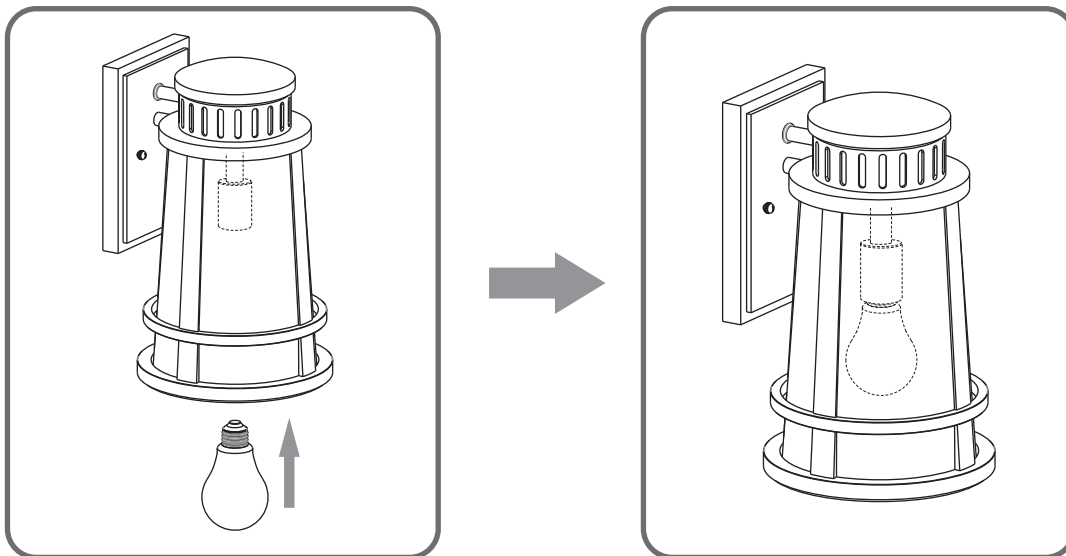

STEP 7

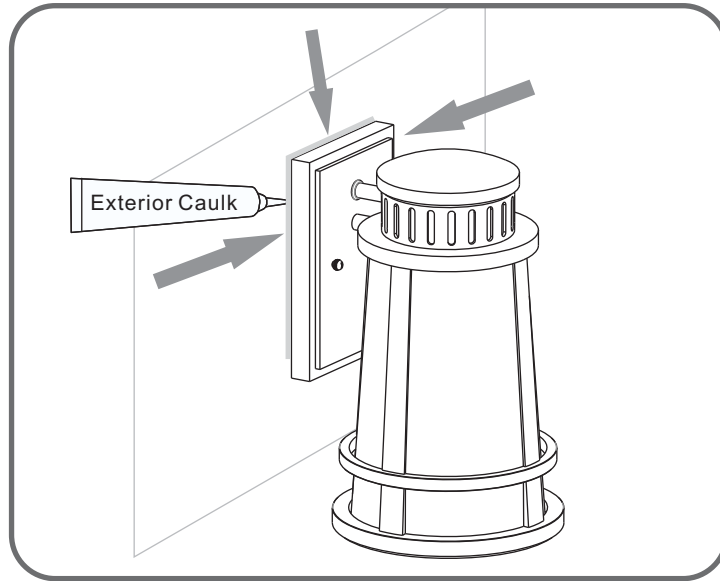

STEP 8 - How to Replace Glass

1

Remove glass holder

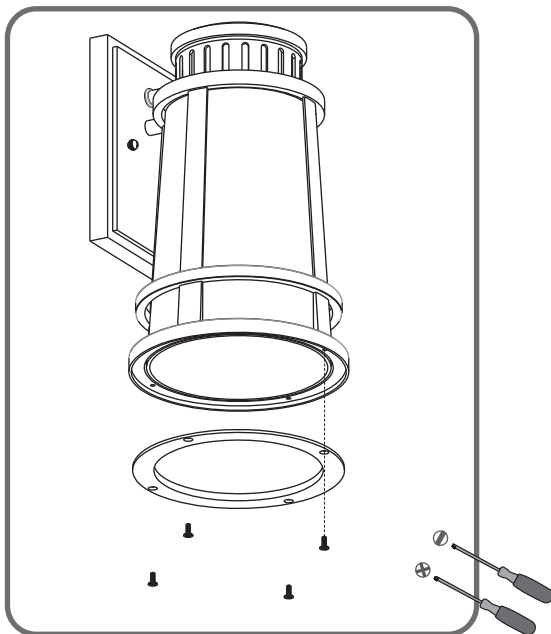

Reinstall glass holder

3

2

Replace glass

