

Assembly Instruction Sheet #IS- 9735W7 For Style 9735W7

Tools Required: Flathead screwdriver, Phillips screwdriver, pliers, wire cutters, wire strippers, electrical tape, safety glasses.
Light Source: (1) E26 60W Max (Not Included).
Estimated Assembly Time: 15-30 minutes.
Preparation: Identify and inspect all parts before beginning installation. Check package content list and diagrams before to be sure all parts are present. If any parts are missing or damaged, do not attempt to assemble, install, or operate the fixture. Contact customer service for replacement parts.

⚠ Warnings and Cautions
 Turn off electricity at circuit breaker or main fuse box before installation. Consult a licensed electrician if in doubt. These instructions are provided for your safety. It is very important you read them completely before installing the fixture. We strongly recommend that a licensed, professional electrician perform the installation. Disconnect fixture from power source before replacing bulbs. Make sure bulbs are given sufficient time to cool before removal.

Package Contents

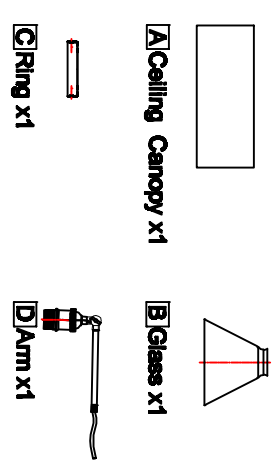

Hardware Contents		
PART	DESCRIPTION	QUANTITY
BB	Wire nut	2pcs
CC	Outlet Box Screw	2pcs

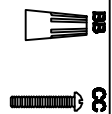

STEP 1 - Release Mounting Bracket from Ceiling Canopy.

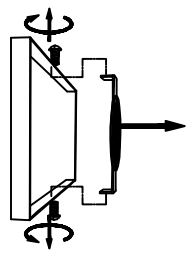

Figure 1

STEP 2 - Install Arm to Ceiling Canopy

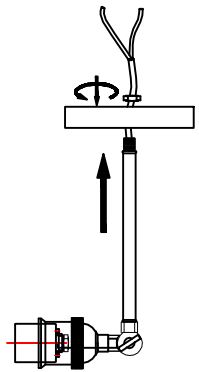

Figure 2

STEP 3 - Attach Mounting Bracket to Outlet Box

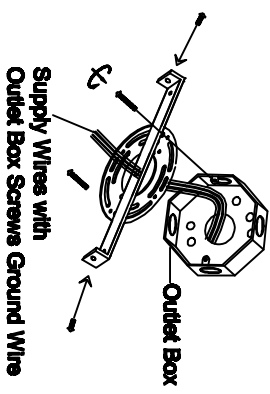

Figure 3

STEP 4 - Wire Connections

A. Use standard wire connectors to make all wire connections. Twist connectors until wires are tightly joined together. Wrap each connection with approved electrical tape and carefully stuff all the connected wires into the Outlet Box:

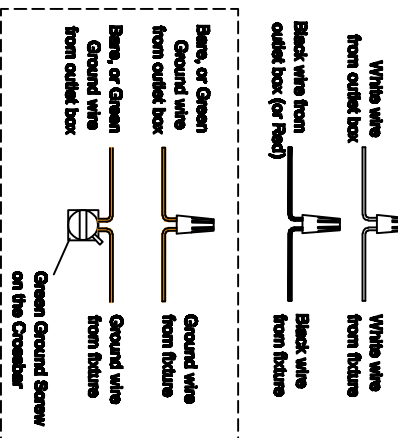

Figure 4

STEP 5 - Install Ceiling Canopy to Ceiling

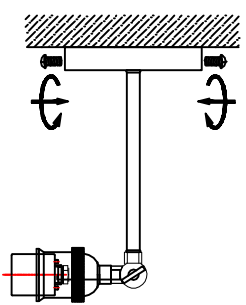

Figure 5

STEP 6 - Install Glass to Fixture Body.

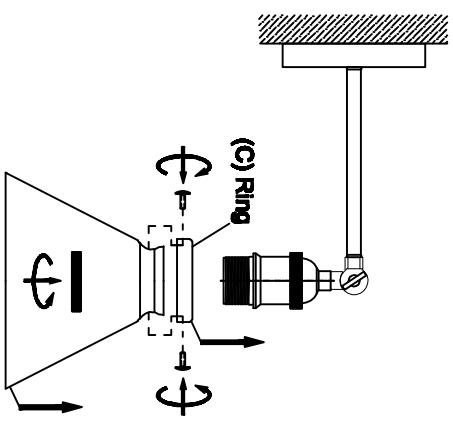

Figure 6