

ASSEMBLY AND INSTALLATION INSTRUCTIONS

P0317

WARNING: TO AVOID RISK OF ELECTRICAL SHOCK, BE SURE TO SHUT OFF POWER BEFORE INSTALLING OR SERVICING THIS FIXTURE.

NOTES: 1. Before installing, consult local electrical codes for wiring and grounding requirements.
2. Read and save these instructions.

Hardware Package (included):

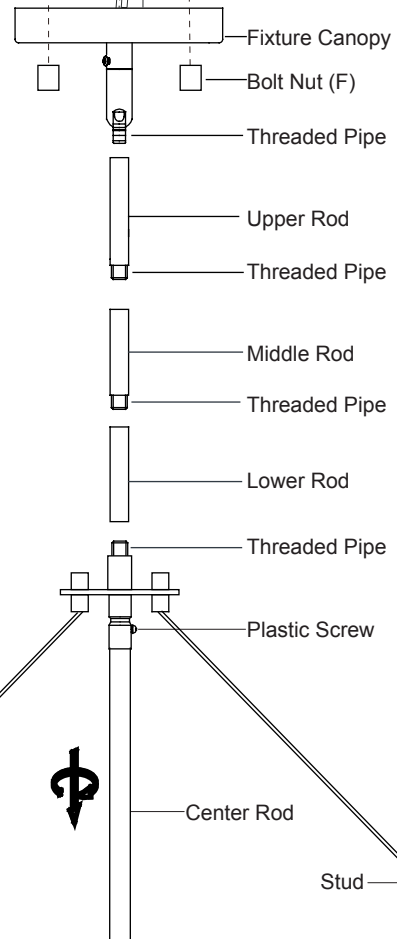
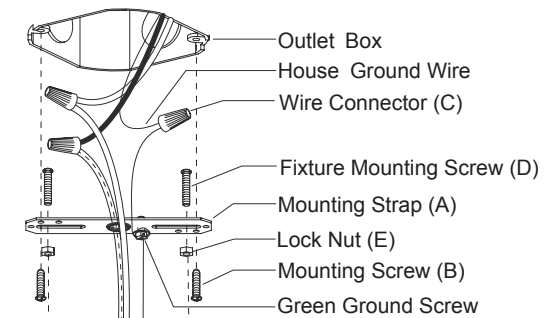
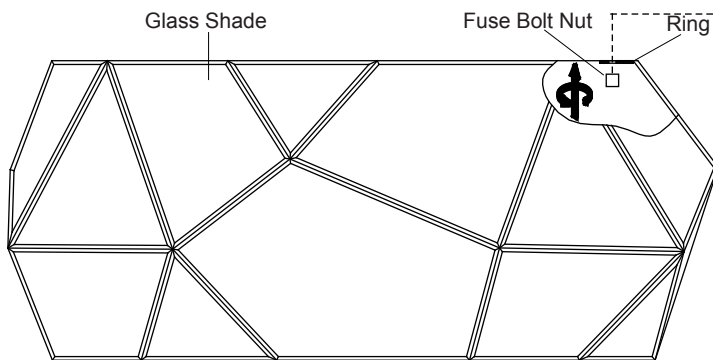
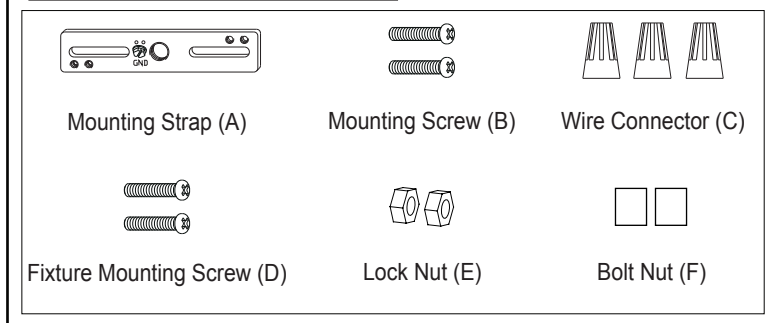

Installation Steps

Turn off the power at fuse or circuit box

1. Thread two fixture mounting screws (D) through the mounting strap (A), then secure with two lock nuts (E). Adjust the length of the fixture mounting screws (D) if necessary.
2. Attach the mounting strap (A) to the outlet box by using two mounting screws (B).
3. Connect the center rod to the fixture by using the threaded pipe.
4. Rod connections:
 - a. Thread the fixture wire from the fixture through the lower rod, then secure the lower rod onto fixture using the threaded pipe.
 - b. Thread the fixture wire through the middle rod, then secure the middle rod onto the lower rod using the threaded pipe.
 - c. Thread the fixture wire through the upper rod, then secure the upper rod onto the middle rod using the threaded pipe.
 - d. Thread the fixture wire through the canopy, then secure the canopy onto the upper rod using the threaded pipe.

Note: Length adjustable from 24-3/8" to 66-3/8". Use fewer rods if shorter length is desired.

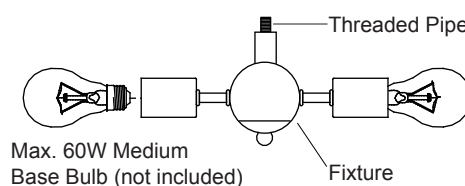

- Pull out the source wires from the outlet box. Make wire connections using wire connectors (C) as follows:
 - Connect the smooth-coated wire (marked) from the fixture to the black wire from the power source.
 - Connect the ribbed-coated wire (unmarked) from the fixture to the white wire from the power source.
 - Attach the fixture ground wire to the mounting strap (A) with the green ground screw, then connect it to the house ground wire with a wire connector (C).
 Carefully put the wires back into the outlet box.

- Attach the fixture canopy to the mounting strap (A) by inserting the fixture mounting screws (D), then secure it with two bolt nuts (F).

- Remove three fuse bolt nuts from three studs, thread the studs through the holes of the rings on the edge of glass shade, then secure them with fuse bolt nuts.

Note: When installing the ring, the ring must be placed as per the tag arrow points upward, do not reverse it.

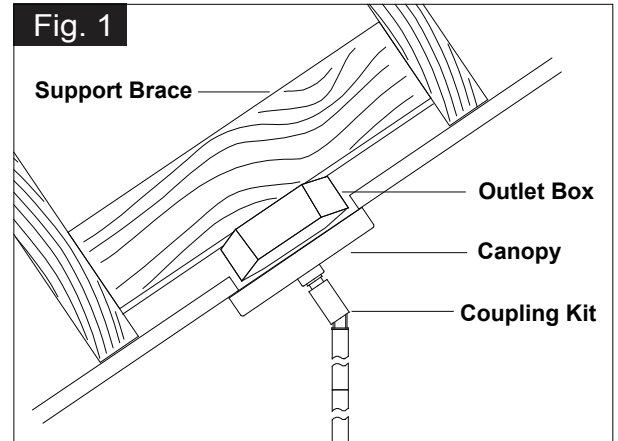

- Install bulbs (not included). Check relamping label at socket area or packaging for maximum wattage allowed.

- Angled mounting recommended for a vaulted or angled ceiling. (See Fig.1)

Turn on the power at fuse or circuit box

The following parts are available for reorder if damaged or missing.

Spare Parts List:

			 Glass Shade 10114MG
Mounting Strap (A)	Mounting Screw (B)	Wire Connector (C)	
			 Mounting Hardware 6159MM (1 SET)
12" Rod 3216RD	6" Rod 3217RD	3" Rod 3218RD	

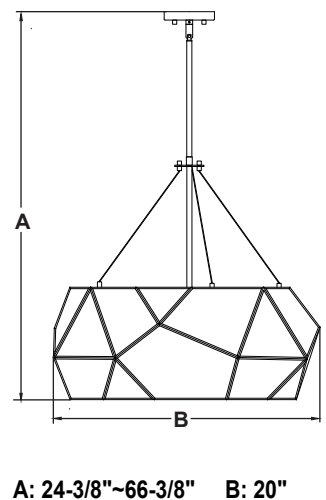

1 Year Warranty

Vaxcel warrants all of our products against defects in workmanship and finishes for one year following the date of shipment.

Exclusions: This warranty does not include the failure of products from extreme acts of nature; environmental conditions not suited for the products intended use; operation in temperatures outside of the range specified in the instruction manual; usage with improper power supply, power surges or dips. For coastal locations, some corrosion is considered normal for the environment.

Vaxcel reserves the right to repair, replace or issue a credit for any properly installed product, provided it is returned per RMA instruction. This warranty is limited to the cost of the product only and does not extend to transportation, installation or replacement costs.

How can warranty service be obtained?

info@vaxcel.com

1-800-482-9235