

RENAISSANCE 3785- _ _ _

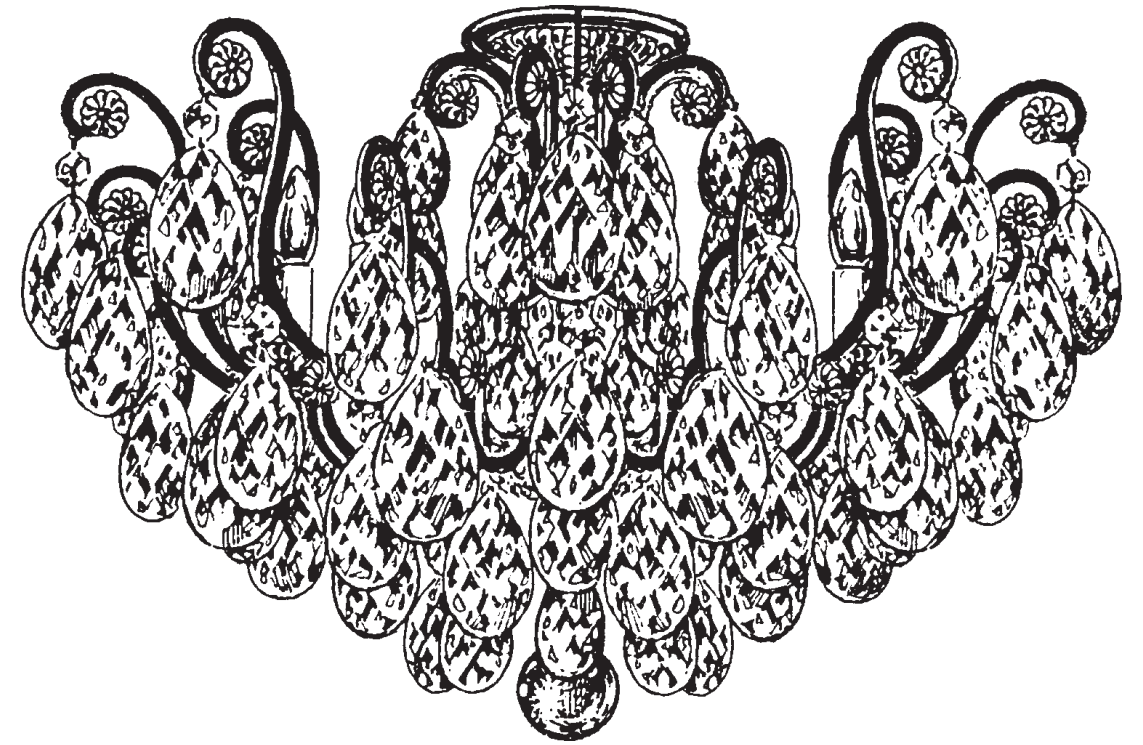

THIS DESIGN IS THE PROPRIETARY TRADE DRESS/TRADemark OF SWAROVSKI LIGHTING, LTD.

8 Lights
Diameter: 26"
Body Length: 18"
Hanging Weight: 30 lbs.



SCHONBEK®



SCHONBEK®

MAX 60 W		110-120 V						

SCHONBEK® is a member of the Swarovski group.

All electrical components must be installed by a licensed electrician in accordance with the National Electric Code and the appropriate local electrical codes.

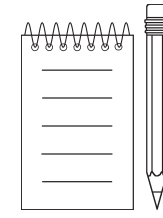
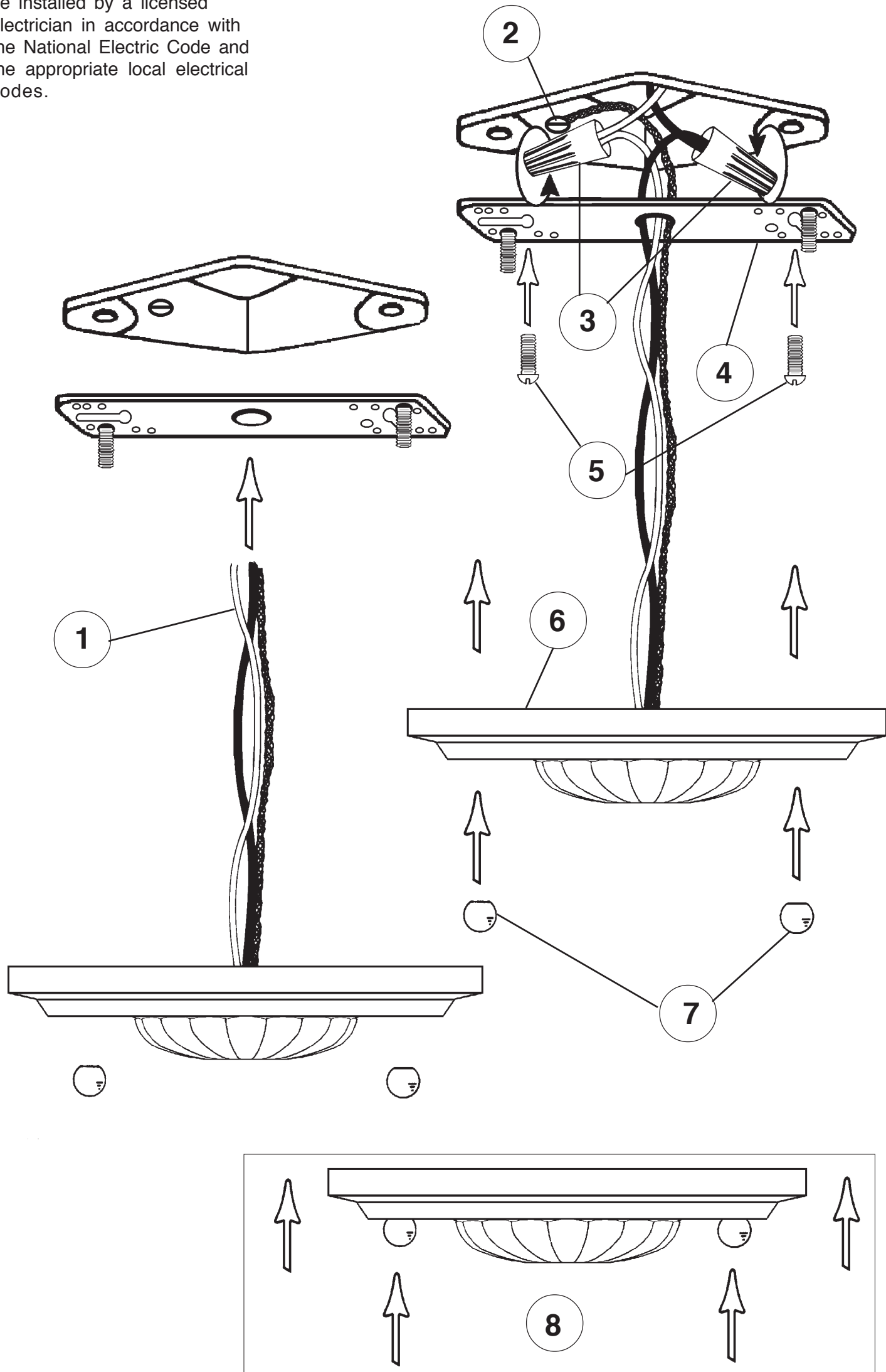

Crystal Set #3 in Black

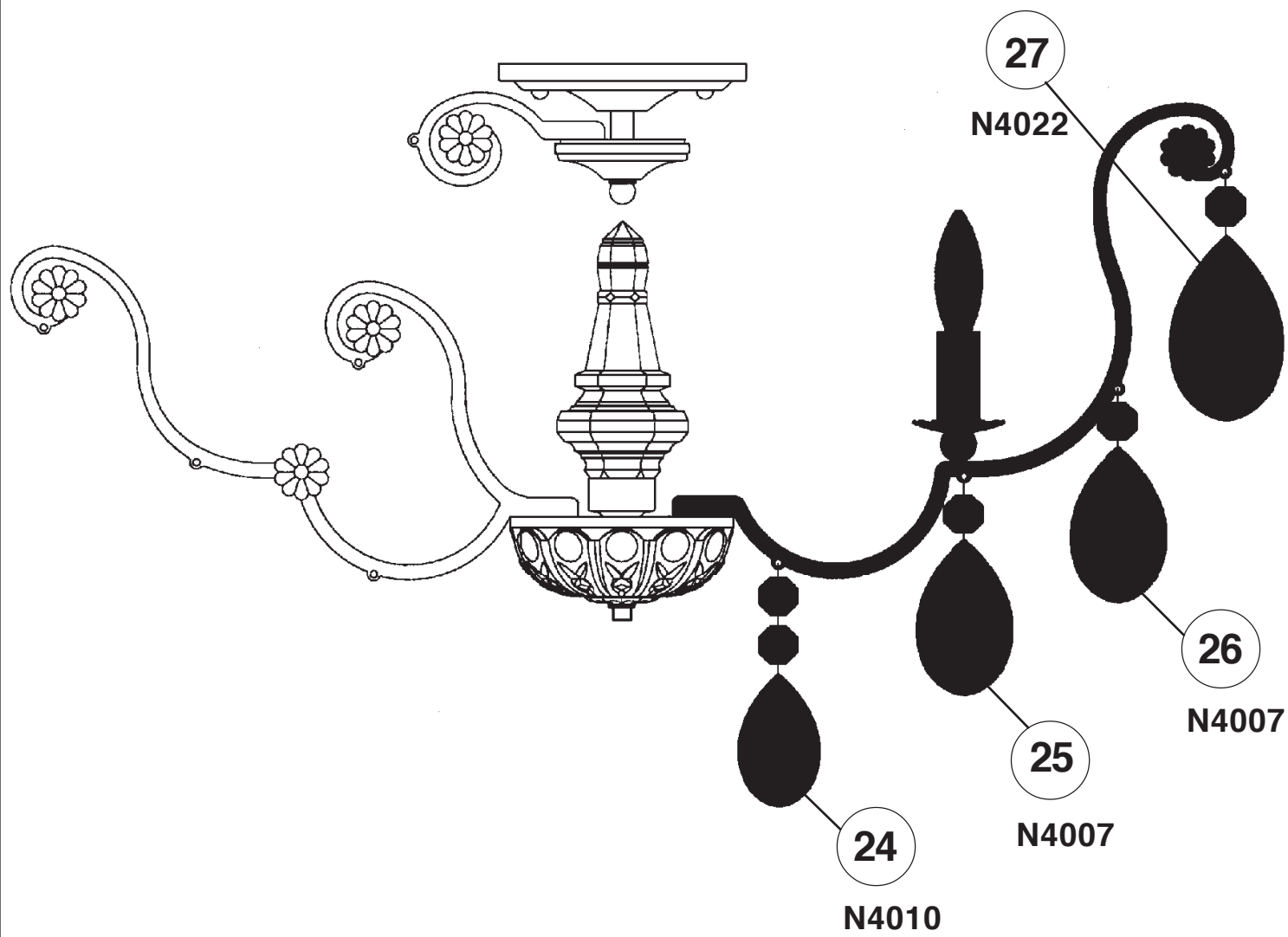

SET #1

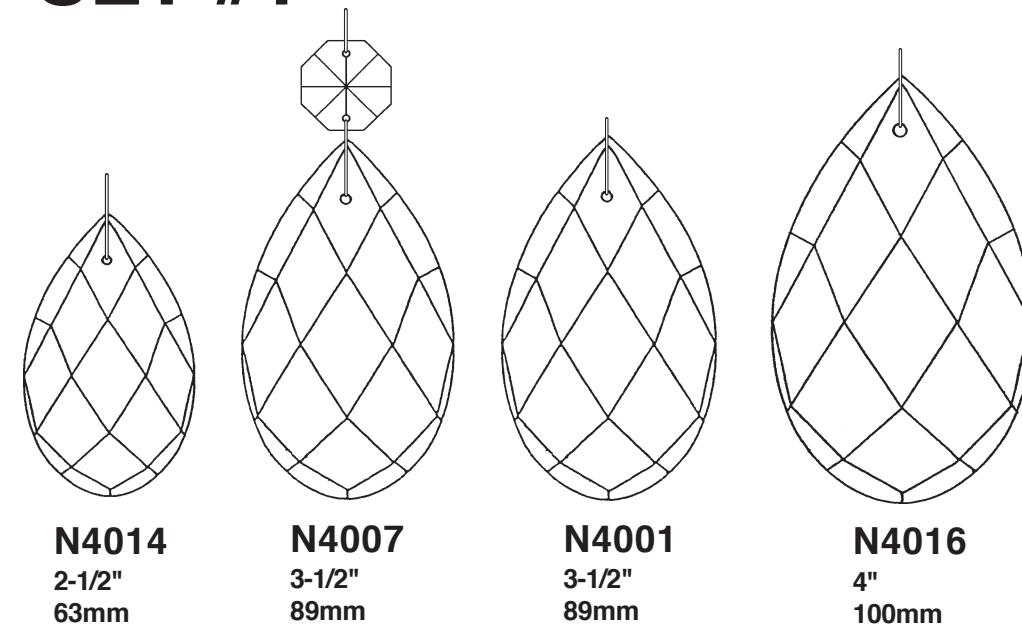

SET #2

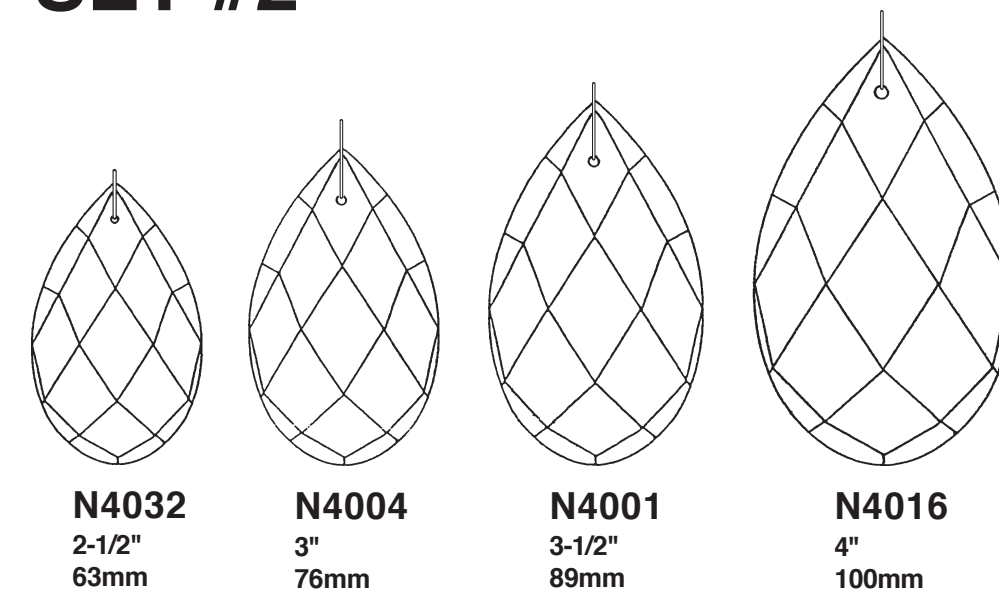

SET #3

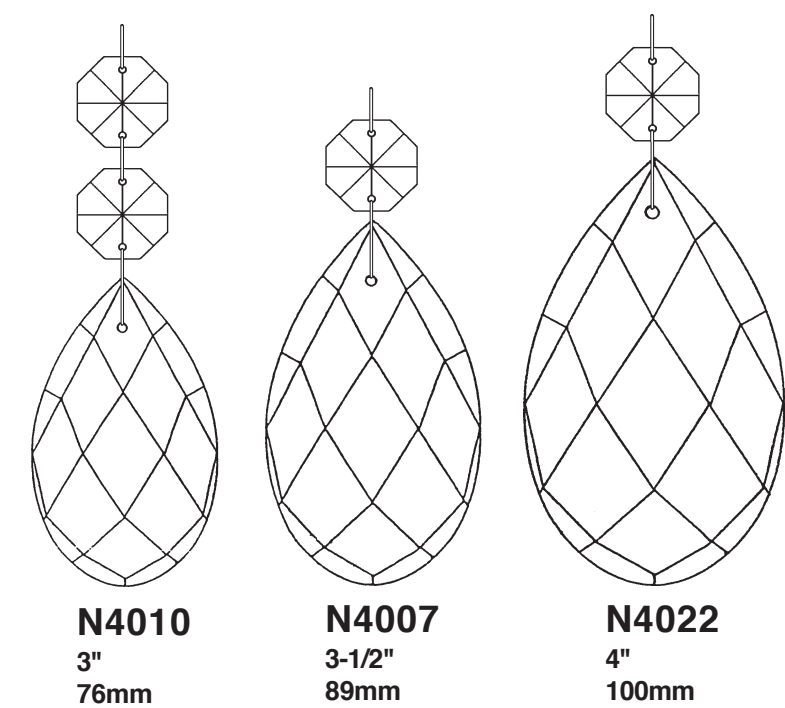

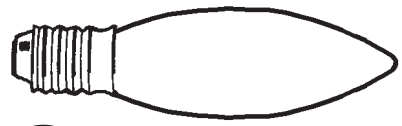

9 8 - B10
60 Watts Max
25 Watts Recommend

Crystal Set #2 in Black

Crystal Set #1 in Black

