

ASSEMBLY INSTRUCTIONS

ITEM NO:BO-2862TB

CAREFULLY UNPACK AND PLACE ALL PARTS ON A SMOOTH SURFACE.

- 1.SCREW SOCKET ASSEMBLY (D) CLOCKWISE INTO LAMP BODY (E) TO TIGHTEN. THEN THE COVER OF THE NON-WOVEN PAD (F) AND STICK IT TO THE BOTTOM OF THE BASE.
- 2.INSERT HARP (C) TO THE SADDLE (D) .
- 3.PLACE SHADE (B) ONTO HARP (C) BY FINIAL (A) CLOCKWISE TO TIGHTEN.
- 4.INSTALL BULB (NOT INCLUDED) INTO THE SOCKET.
- 5.INSERT THE POWER PLUG INTO AND OUTLET AND ENJOY !!

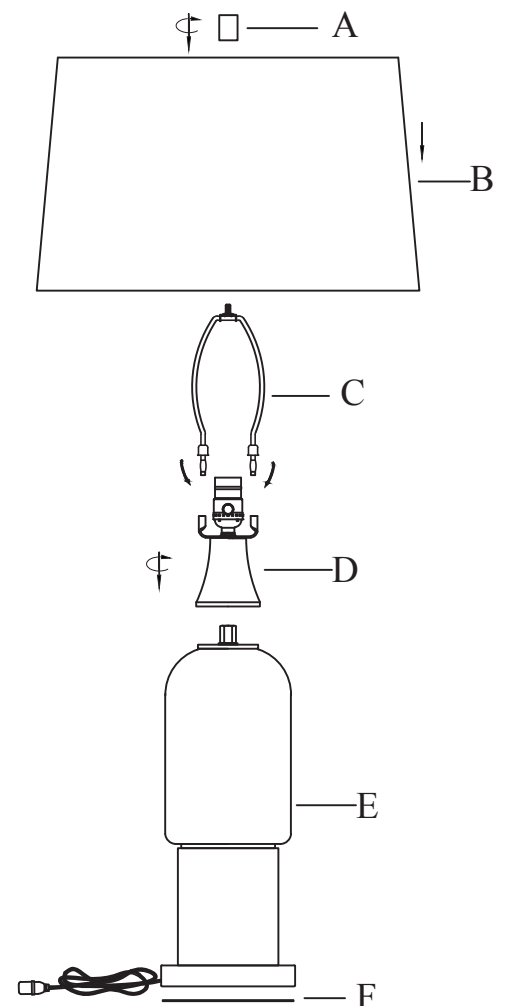

Use MAX 3-way 150 Wattage type A bulb (bulb not included)

IMPORTANT SAFETY INSTRUCTIONS:

SAVE THESE INSTRUCTIONS FOR FUTURE REFERENCE.

THIS PORTABLE LAMP HAS A POLARIZED PLUG (ONE BLADE IS WIDER THAN THE OTHER) AS A FEATURE TO REDUCE THE RISK OF ELECTRIC SHOCK. THIS PLUG WILL FIT IN A POLARIZED OUTLET ONLY ONE WAY. IF IT DOES NOT FIT FULLY IN THE OUTLET, REVERSE THE PLUG. IF IT STILL DOES NOT FIT, CONTACT A QUALIFIED ELECTRICIAN. NEVER USE WITH AN EXTENSION CORD UNLESS THE PLUG CAN BE FULLY INSERTED. DO NOT ALTER THE PLUG.