

WARNING

**DISCONNECT POWER BEFORE RE-LAMPING OR WIRING THE FIXTURE
 READ ALL INSTRUCTIONS COMPLETELY BEFORE STARTING INSTALLATION.**

CAUTION

- TO AVOID THE RISK OF FIRE OR SHOCK, FIXTURE MUST BE INSTALLED IN COMPLIANCE WITH ALL APPLICABLE NATIONAL AND LOCAL ELECTRICAL/BUILDING CODES.
- INSTALLATION AND MAINTENANCE OF THIS UNIT REQUIRES AN ELECTRICIAN OR CERTIFIED FACTORY TRAINED TECHNICIAN.
- If an existing fixture is being replaced, remove it and note to which of the wires in the outlet box the fixture was attached. DO NOT SEPARATE ANY OTHER WIRES THAT MAY BE IN THE BOX. DO NOT DAMAGE THE INSULATION OF OLDER WIRING. In regular circumstances the BLACK wire will be the "Hot" lead and the WHITE wire will be the "Neutral" or "Common" lead. A GREEN or BARE COPPER wire is the "Ground". In older buildings it is always good practice to reconfirm the polarity of the wiring.

NOTICE

- The important safeguards and instructions outlined on this sheet cannot cover all possible conditions and situations that may occur. It must be understood that common sense, caution and care factors that cannot be built into any product. Caution and care must be supplied by the person(s) installing, operating and caring of this lighting fixture.
- This fixture is designed to be mounted on a correctly installed standard round or octagon box or a through wiring box with a plaster frame. The box must be securely mounted to the structure of the building. The mounting plate and hardware supplied should be used. Directly mounting the fixture to the outlet box may make it impossible to correctly align the fixture.

NOTICE:

CALIFORNIA PROP 65: THIS LIGHTING FIXTURE CONTAINS CHEMICALS KNOWN TO THE STATE OF CALIFORNIA TO CAUSE CANCER, BIRTH DEFECTS, AND/OR OTHER REPRODUCTIVE HARM. WASH HANDS AFTER USE.

FIXTURE PREPARATION

1. Remove the fixture, parts and parts bag(s) from the carton.

NOTICE:

- Before discarding the carton, double check to make certain that all parts are found.

FIXTURE INSTALLATION

1. Attach the mounting plate onto the junction box using mounting screws (the green screw should face the floor). Adjust the studs so that they extend 3/16" beyond the canopy. Attach the toggle bolts (supplied by others) to keep the fire plate from bending. (SEE FIGURE-01)
2. Attach the fixture onto the canopy's loops using supplied chain at desired height. Remove excess chains and close all links.

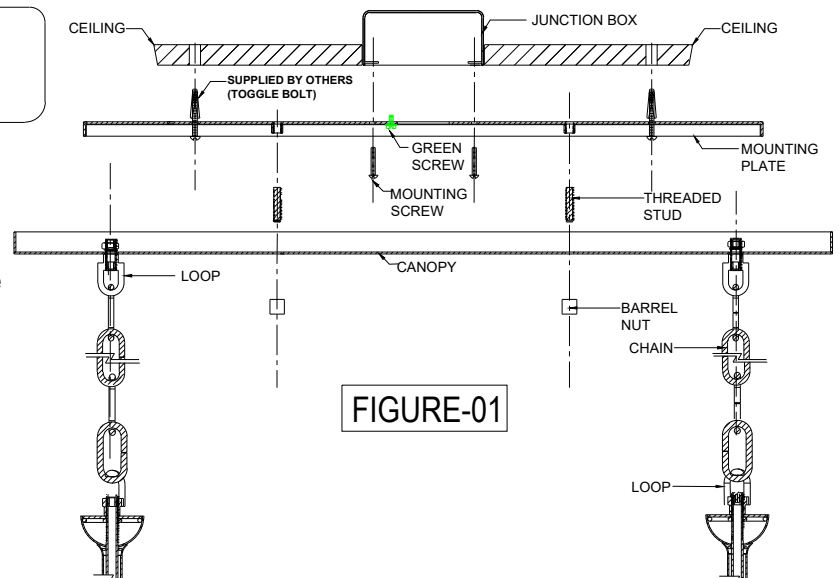
FIGURE-01

! WARNING

The use of chain pliers for opening and closing chain is required. The use of tools other than the chain pliers may damage the chain link resulting in a failure which causes harm to the fixture, property and/or person!

3. Measure 6" of lead and ground wire beyond the top of the chain. Cut off excess wire. Strip the insulation off the ends of the leads exposing approx. 1/2" of wire. Twist the strands of wire together. Push the leads and ground wire up through the fabricated loop and into the junction box.

4. Fasten the ground wire to the green or bare copper wire in the junction box of the green screw of the mounting plate.

! WARNING

Never fasten the ground wire to the black or hot wire! Failure to follow instruction could result in serious injury or death!

5. Fasten the fixture's lead hot wire to hot wire in the junction box. Fasten the wires together with an approved fastener(wire nut). Starting about 1" below the fastener, tightly wrap the connection with electrical tape so that the connections seals the end of the fastener. NOTE: SPT Hot Wire is the one with the writings.

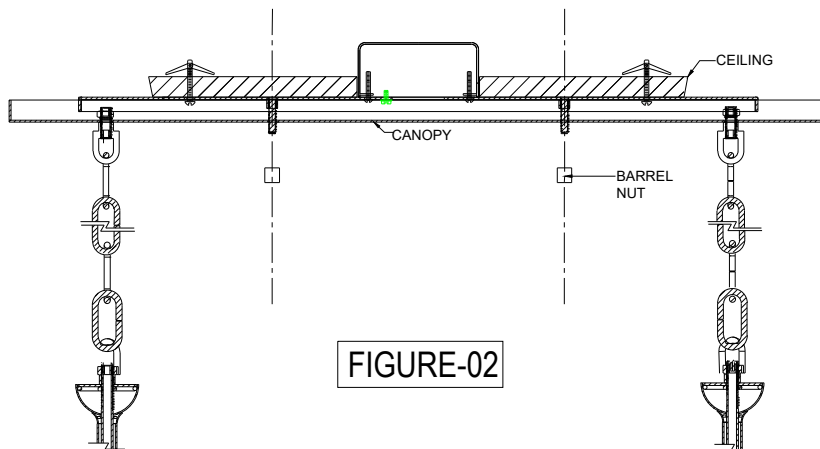

! WARNING

Make sure that there is no exposed wire or strands that could cause a dangerous short circuit!

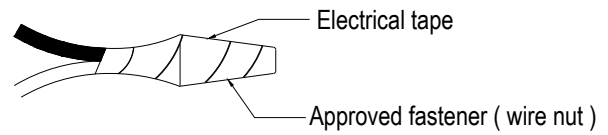

6. Connect the fixture lead's neutral wire to the neutral wire in the junction box. Fasten the joined wires as in step 5. NOTE: SPT Cord's Neutral wire does not have any writings on it.

7. Pull up and attach the canopy onto the mounting plate and secure it with barrel nuts. (SEE FIGURE-02)

8. Place the lamp into the socket of the fixture. (SEE FIGURE-03)

NOTICE:

This fixture is rated for 60w TYPE-B.

! WARNING

DO NOT EXCEED RECOMMENDED WATTAGE!

9. Attach the fabric shade to the fixture by fastening its clips onto the bulb. (SEE FIGURE-04)

10. Restore power to the circuit breaker or fuse box.

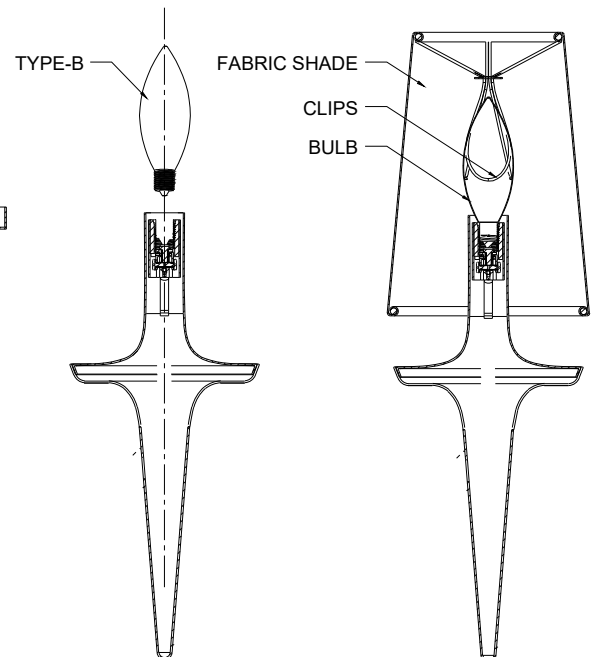

FIGURE-03

FIGURE-04

PARTS LIST

6658

ITEM NUMBER	PART NUMBER	DESCRIPTION
1	R-VU90-HRD AND R-VU90B-HRD	MOUNTING HARDWARE
2	R-VU90-BCN AND R-VU90B-BCN	CANOPY
3	R-VU90-DCH AND R-VU90B-DCH	CHAIN
4	R-VU90-DLC AND R-VU90B-DLC	FABRICATED LOOP
5	R-VU90-FRM AND R-VU90B-FRM	FRAME
6	R-VU90-GSH AND R-VU90B-GSH	FABRIC SHADE

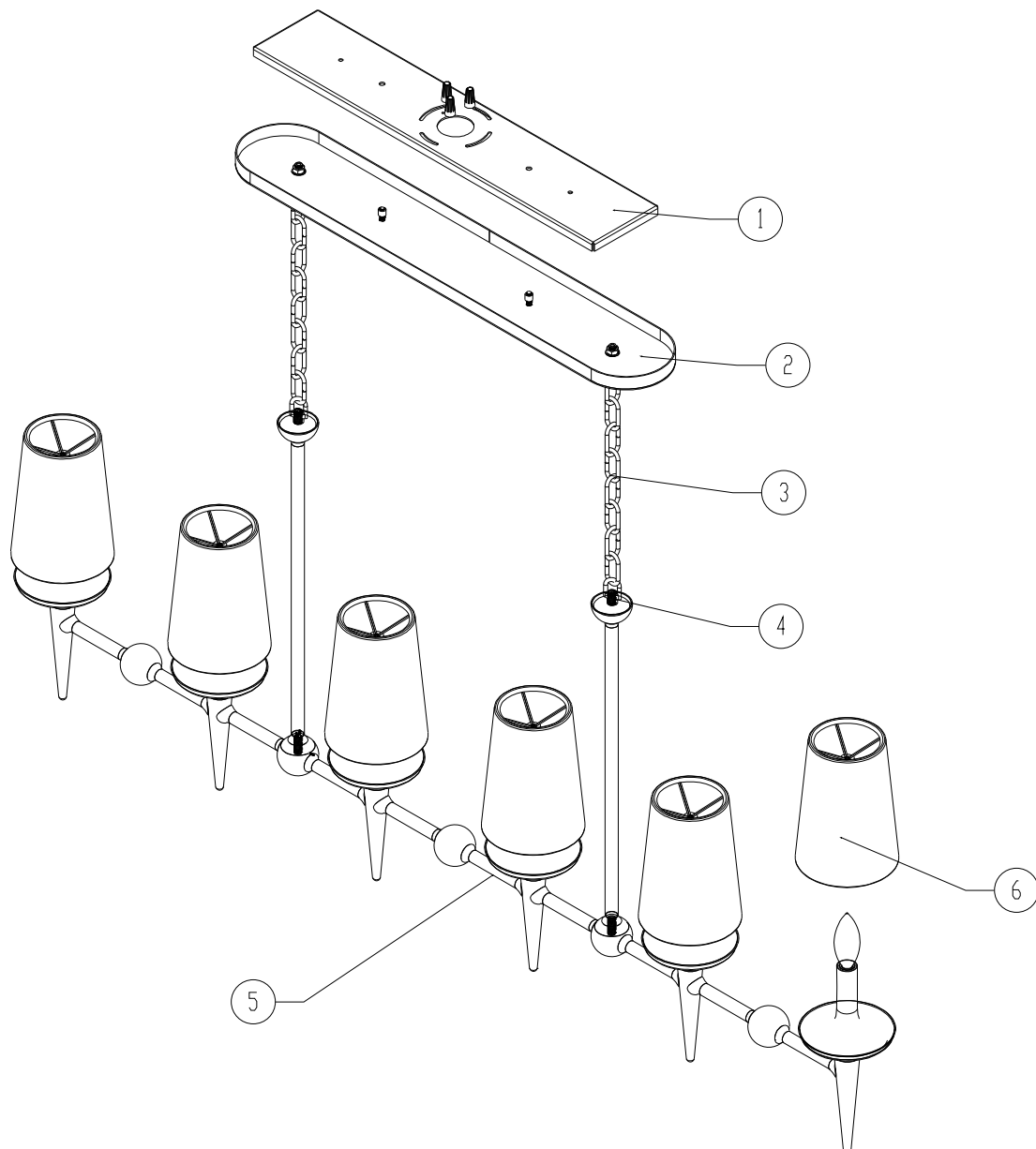

⚠ ATTENTION

DÉBRANCHEZ L'ALIMENTATION AVANT DE REMPLIR OU DE CÂBLER LE LUMINAIRE
 LISEZ COMPLÈTEMENT TOUTES LES INSTRUCTIONS AVANT DE COMMENCER L'INSTALLATION.

⚠ AVERTIR

- POUR ÉVITER LES RISQUES D'INCENDIE OU D'ÉLECTROCUTION, LE LUMINAIRE DOIT ÊTRE INSTALLÉ CONFORMÉMENT TOUS LES CODES NATIONAUX ET LOCAUX APPLICABLES EN MATIÈRE D'ÉLECTRICITÉ ET DE CONSTRUCTION.
- L'INSTALLATION ET L'ENTRETIEN DE CET APPAREIL NÉCESSITENT UN ÉLECTRICIEN OU TECHNICIEN CERTIFIÉ FORMÉ EN USINE.
- Si un luminaire existant est remplacé, retirez-le et notez à quel fil de la boîte de jonction le luminaire était attaché. NE SÉPAREZ AUCUN AUTRE FIL PEUVENT ÊTRE DANS LA BOÎTE. N'ENDOMMAGEZ PAS L'ISOLATION DE L'ANCIEN CÂBLAGE. Dans des circonstances normales, le fil NOIR sera le fil "chaud" et le fil BLANC sera le fil "neutre" ou "commun" Un fil VERT ou CUIVRE NU est la "Masse". Dans les bâtiments plus anciens, il est toujours recommandé de reconfirmer la polarité du câblage.

AVIS

- Les garanties et instructions importantes décrites sur cette fiche ne peuvent pas couvrir toutes les conditions et situations possibles qui peut se produire. il faut comprendre que le bon sens, la prudence et les soins sont des facteurs qui ne peuvent être intégrés à aucun produit. La prudence et les soins doivent être fournis par la ou les personnes qui installent, utilisent et entretiennent cet appareil d'éclairage.
- Ce luminaire est conçu pour être monté sur une boîte ronde ou octogonale standard correctement installée ou une boîte de câblage traversante avec un cadre en plâtre. La boîte doit être solidement fixée à la structure du bâtiment. La barre transversale et la quincaillerie fourni doit être utilisé. le montage direct du luminaire sur la boîte de jonction peut rendre impossible l'alignement correct du luminaire.

AVIS:

CALIFORNIE PROP 65 : CET APPAREIL D'ÉCLAIRAGE CONTIENT DES PRODUITS CHIMIQUES CONNUS PAR L'ÉTAT DE CALIFORNIE POUR PROVOQUER LE CANCER, DES MALADIES CONGÉNITALES ET/OU D'AUTRES DOMMAGES À LA REPRODUCTION. LAVER LES MAINS PRÈS UTILISATION.

FIXTURE PREPARATION

1. Remove the fixture, parts and parts bag(s) from the carton.

NOTICE:

- Before discarding the carton, double check to make certain that all parts are found.

FIXTURE INSTALLATION

1. Attach the mounting plate unto the junction box using mounting screws (the green screw should face the floor). Adjust the studs so that they extend 3/16" beyond the canopy. Attach the toggle bolts(supplied by others) to keep the fire plate from bending. (SEE FIGURE-01)
2. Attach the fixture unto the canopy's loops using supplied chain at desired height. Remove excess chains and close all links.

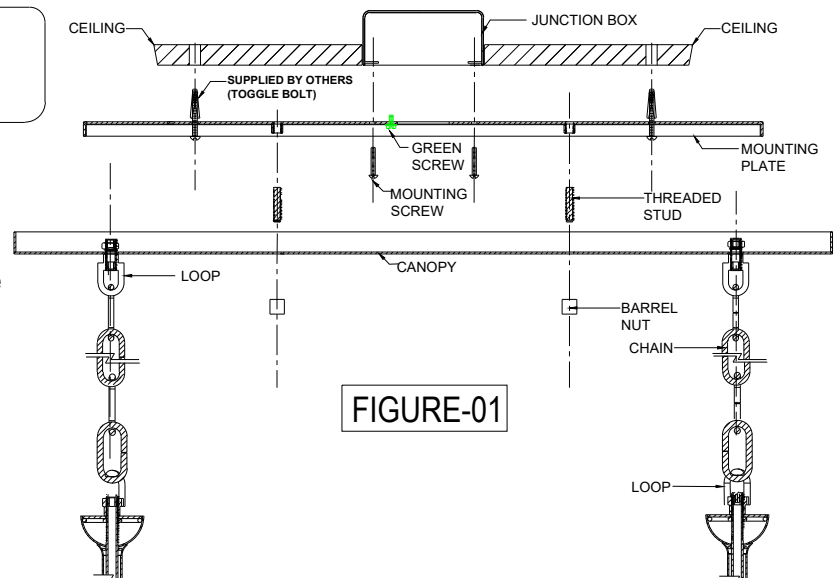



WARNING

The use of chain pliers for opening and closing chain is required. The use of tools other than the chain pliers may damage the chain link resulting in a failure which causes harm to the fixture, property and/or person!

3. Measure 6" of lead and ground wire beyond the top of the chain. Cut off excess wire. Strip the insulation off the ends of the leads exposing approx. 1/2" of wire. Twist the strands of wire together. Push the leads and ground wire up through the fabricated loop and into the junction box.

4. Fasten the ground wire to the green or bare copper wire in the junction box of the green screw of the mounting plate.



WARNING

Never fasten the ground wire to the black or hot wire! Failure to follow instruction could result in serious injury or death!

5. Fasten the fixture's lead hot wire to hot wire in the junction box. Fasten the wires together with an approved fastener(wire nut). Starting about 1" below the fastener, tightly wrap the connection with electrical tape so that the connections seals the end of the fastener. NOTE: SPT Hot Wire is the one with the writings.



WARNING

Make sure that there is no exposed wire or strands that could cause a dangerous short circuit!

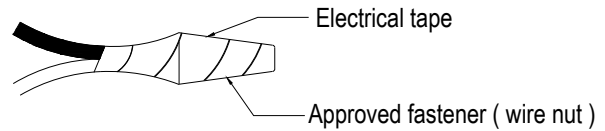

6. Connect the fixture lead's neutral wire to the neutral wire in the junction box. Fasten the joined wires as in step 5. NOTE: SPT Cord's Neutral wire does not have any writings on it.

7. Pull up and attach the canopy into the mounting plate and secure it with barrel nuts. (SEE FIGURE-02)

8. Place the lamp into the socket of the fixture. (SEE FIGURE-03)

NOTICE:

This fixture is rated for 60w TYPE-B.



WARNING

DO NOT EXCEED RECOMMENDED WATTAGE!

9. Attach the fabric shade to the fixture by fastening its clips onto the bulb. (SEE FIGURE-04)

10. Restore power to the circuit breaker or fuse box.

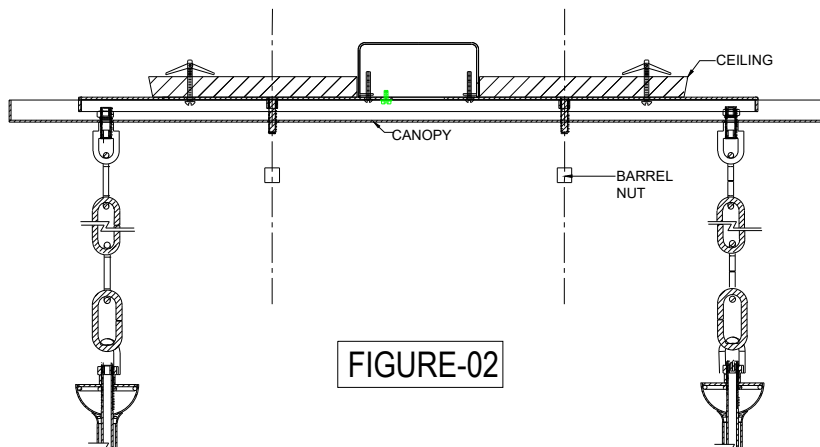

FIGURE-02

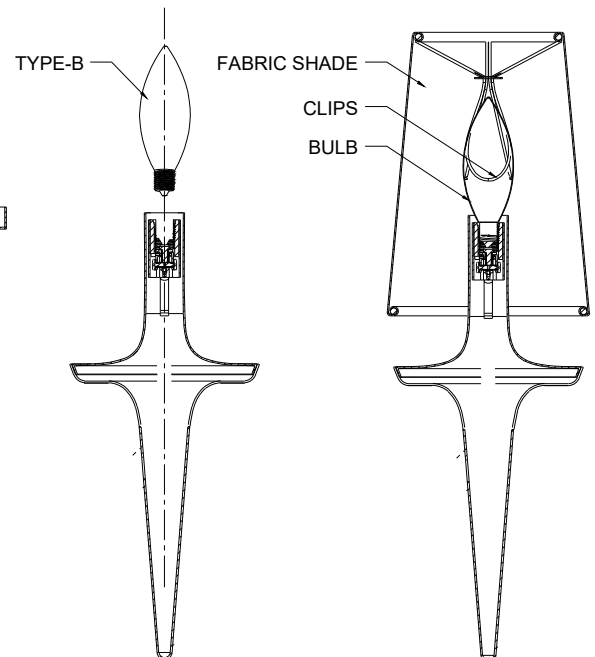

FIGURE-03

FIGURE-04

PARTS LIST

6658

ITEM NUMBER	PART NUMBER	DESCRIPTION
1	R-VU90-HRD AND R-VU90B-HRD	MOUNTING HARDWARE
2	R-VU90-BCN AND R-VU90B-BCN	CANOPY
3	R-VU90-DCH AND R-VU90B-DCH	CHAIN
4	R-VU90-DLC AND R-VU90B-DLC	FABRICATED LOOP
5	R-VU90-FRM AND R-VU90B-FRM	FRAME
6	R-VU90-GSH AND R-VU90B-GSH	FABRIC SHADE

