

READ & SAVE THESE INSTRUCTIONS

INSTALLATION & OPERATION INSTRUCTIONS

MODEL NO. 20290

Voltage: 110V~130V

Wattage: 60W 100W

CAUTION: Before assembling your lighting fixture refer to the section titled electrical connections, If you feel you do not have electrical wiring experience refer to a do it yourself wiring handbook or have your fixture installed by a qualified licensed electrician.

GENERAL

1. To ensure the success of the installation be sure to read these instructions and review the diagrams thoroughly before beginning.
2. All electrical connections must be in accordance with local codes ordinances or the national electrical code if you are unfamiliar with methods of installing electrical wiring secure the services of a qualified licensed electrician.
3. These fixtures are intended to be mounted to a 4" x 2 1/8 deep metal octagon outlet box. The box must be directly supported by the building structure.
4. Before starting the installation disconnect the power by turning off the circuit breaker or by removing the fuse at the fuse box, Turning the power off using the light switch is not sufficient to prevent electrical shock.

NOTE the important safeguards and instructions appearing in this manual are not meant to cover to all possible conditions and situations that may occur. It must be understood that common sense caution and care are factors which cannot be built into any product these factors must be supplied by the persons(s) using for and operating the fixture.

UNPACK THE FIXTURE

Check the contents of the box You should receive.

- Mounting bracket
- Mounting hardware Fixture with glass and decorative guard.

PREPARE THE FIXTURE

NOTE: FIRST TURN OFF ELECTRICITY

1. If you are replacing an existing fixture disconnect and remove the old fixture expose the supply wiring from the outlet box.
2. Separate the glass from the fixture by removing the two screws on the decorative guard.
3. If your fixture is supplied with a threaded stem for mounting refer to figure 1 and follow step 4 If your fixture is supplied with 2 machine screws refer to figure 2 and follow step 5.
4. If your fixture is supplied with a threaded nipple screw the nipple 3 complete turns into the mounting bracket and lock into place with a hexagon locknut.

5. If your fixture is supplied with two machine screws thread the machine screws into the opposite side of the mounting bracket from the green grounding screw.
6. Fasten the mounting bracket to the outlet box using the two screws provided. The machine screws or threaded nipple should be facing the outward direction.
7. While supporting the fixture cover plate connect the grounding wire (green or bare copper) from the fixture to the grounding conductor of the supply circuit. Attach all of the grounding conductors to the mounting bracket with the green grounding attachment screw.
8. Make electrical connections - see below:

ELECTRICAL CONNECTIONS

To make electrical connections:

Connect the white wire(s) from the fixture to the white wire of the supply circuit. Connect the black wire(s) from the fixture to the black wire of the supply circuit. Use U.L listed wire connectors suitable for the size type and number of conductors. No loose strands or loose connections should be present. Secure the wire connectors with U.L listed electrical tape.

FINAL ASSEMBLY

1. Spread the electrical splices so that the black wires are on one side of the outlet box and the white wires are on the other side.
2. Place the fixture against the mounting surface allowing the machine screws or threaded nipple to pass through the fixture cover plate. Secure with the acorn nuts or mounting nut provided.
3. Install the light bulb(s) (not provided)
Caution: Refer to the relamping label located near the lampholder or the recommended maximum wattage, do not exceed recommended wattage.
4. Secure the glass and decorative guard to the fixture with the screws provided.
5. Outdoor wall fixtures must be caulked with suitable PTV or silicone compound around the top and sides of the cover plate to reduce the chance of water entering into the splicing area. Leave the bottom entering into the bottom clear to allow moisture a means to escape.
6. Restore electricity and check the operation of your lighting fixture.

access
LIGHTING

WARNING

RISK OF FIRE MOST DWELLINGS BUILT BEFORE 1985 HAVE SUPPLY WIRE RATED 75°C CONSULT A QUALIFIED ELECTRICIAN BEFORE INSTALLING.

FIG 1

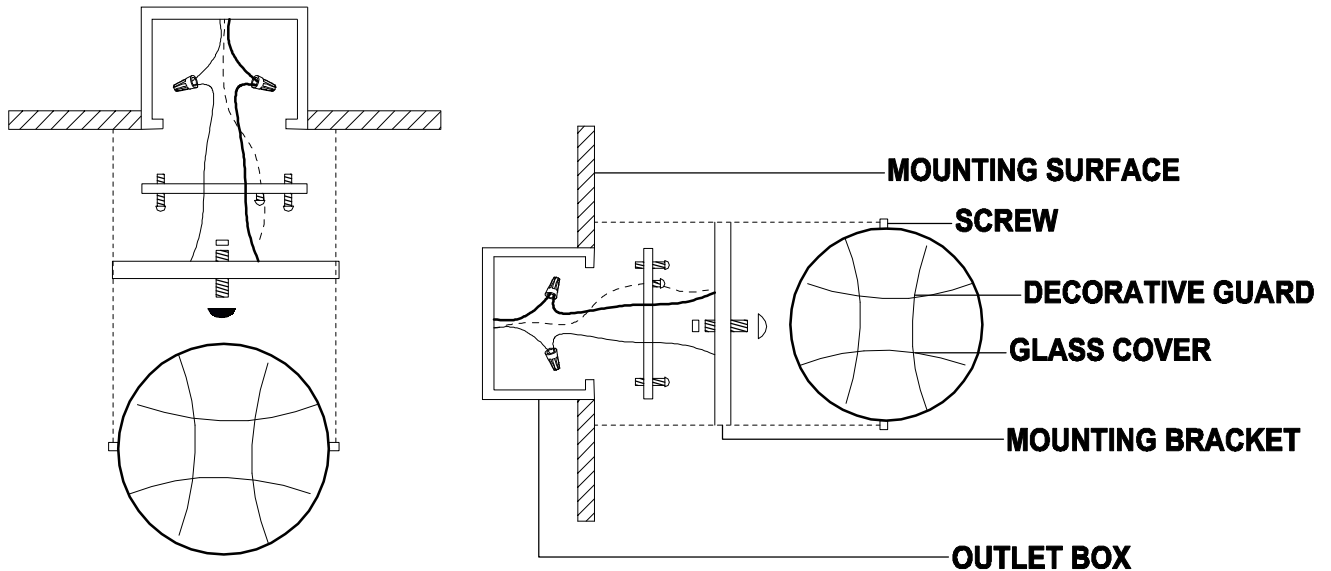

FIG 2

