

# ASSEMBLY AND INSTALLATION INSTRUCTIONS

T0669 / T0670

**WARNING: Turn off the main power at circuit breaker before installing fixture.**  
**AVERTISSEMENT: Coupez la source d'alimentation principale au panneau central de disjoncteurs avant d'installer le luminaire.**

**NOTE: 1. Before installing, consult local electrical codes for wiring and grounding requirements.**  
**2. Read and save these instructions.**

## Important to Know

1. Read all instructions carefully before installation and operation.
2. If you are not familiar with state and local electrical codes, it is recommended that you consult with a qualified electrician.
3. Before installation, shut off power at the main fuse or circuit breaker box. Be aware that simply turning off the wall switch is not sufficient to prevent an electrical shock.
4. This fixture requires a 120V AC, 60 Hz power source.
5. Do not attempt to take the lantern apart; there are no serviceable parts inside.
6. To avoid sensor damage by lightning or electrical surge, make sure the ground wire is securely connected.
7. For general safety and to avoid any possible damage to the sensor, be sure the power is switched "off" before replacing the bulb.
8. Compatible with most LED dimmable bulbs.

**Maximum Wattage: 60W Bulb**

**Work Temperature: - 22°F~104°F**

## Features

1. Energy saving fixture.
2. Use dim-to-full brightness where dim-illumination is preferred, such as your front entrance. Use off-to-full brightness where off/on illumination is preferred, such as your backyard.
3. When in manual override mode, use wall switch to keep the light ON till dawn.

## Hardware Package (included):

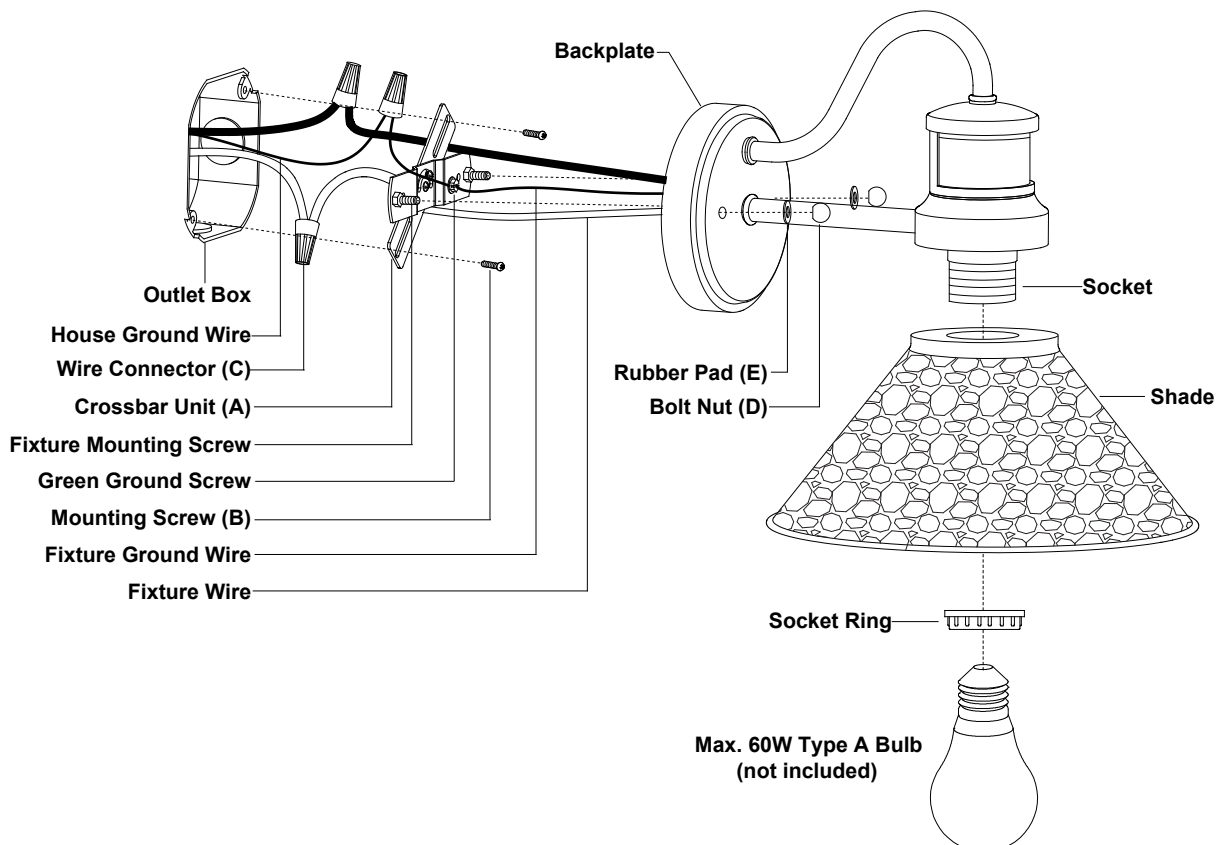
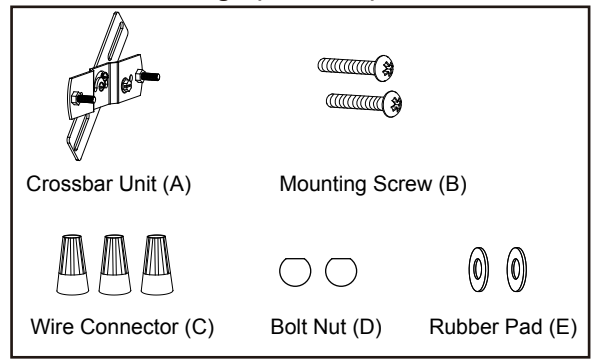

## Installation Steps

Turn off the power at fuse or circuit box

1. Attach the crossbar unit (A) to the outlet box by using two mounting screws (B). Adjust the length of the preinstalled fixture mounting screws if necessary.

**Note: Make sure that the fixture mounting screws are lined up horizontally to make the fixture level.**

2. Pull out the source wires from the outlet box. Make wire connections using wire connectors (C) as follows:

- Connect the hot wire (black insulation) from the fixture to the black wire from the power source.
- Connect the neutral wire (white insulation) from the fixture to the white wire from the power source.
- Attach the fixture ground wire (bare wire) to the crossbar unit (A) with the green ground screw, then depending on local code, connect it to the house ground wire with the wire connector (C).

Carefully put all of the wires back into the outlet box.

3. Attach the backplate of the fixture to the crossbar unit (A) by inserting fixture mounting screws into open holes on the backplate, then secure it with two rubber pads (E) and two bolt nuts (D).

**Note: With silicone caulk compound, caulk completely around where the backplate meets with the wall surface to prevent water from seeping into the outlet box.**

4. Attach the shade to the socket, then secure it with the socket ring.

5. Install the bulb (not included). Check relamping label at socket area or packaging for maximum wattage allowed.

Turn on the power at fuse or circuit box.

## The Position of Control Panel

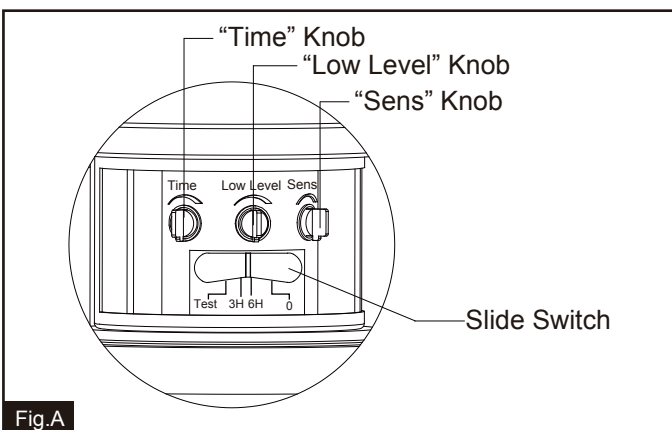
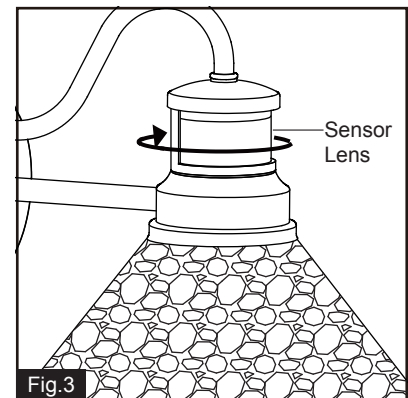
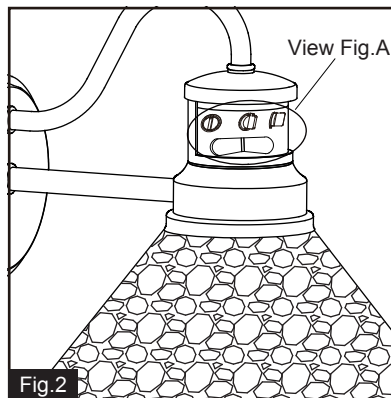
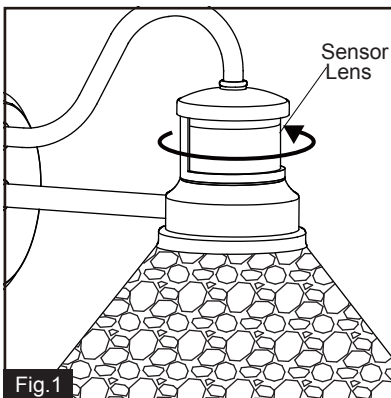

Step 1: Rotate the sensor lens from left side to right side to show the adjustable knobs and slide switch. (See Fig.1)

Step 2: Adjust time, low level brightness and sensitivity by knobs and choose the mode you want by slide switch. (See Fig.2 and Fig.A)

Step 3: Restore the sensor lens to original position. (See Fig.3)

# Function and Operation

## MODES OF OPERATION

Choose a mode by sliding the switch on the back of the sensor. When power is first applied, the light will turn on immediately. Wait for 30 seconds to allow the sensor to warm up.

### 1. TEST MODE (daytime and nighttime operation)

- The light will turn to low-level brightness (0%~50% brightness). The light will turn to high-level brightness (100% brightness) when motion is detected, and stay on as long as the motion is continuing. The light will revert to low-level brightness about 5 seconds after motion is no longer detected.

### 2. 3H MODE (nighttime operation only)

- At dusk, the light will turn to high-level brightness (100% brightness). The light will turn to low-level brightness (0%~50% brightness) automatically after 3 hours. The light will turn to high-level brightness (100% brightness) when motion is detected, and stay on as long as the motion is continuing. When motion is no longer detected, the light will remain on for the predetermined time you set (5~180 seconds), and then revert to low-level brightness you set.
- Light will turn off automatically at dawn, and return to 3 H mode at dusk.

### 3. 6H MODE (nighttime operation only)

- At dusk, the light will turn to high-level brightness (100% brightness). The light will turn to low-level brightness (0%~50% brightness) automatically after 6 hours. The light will turn to high-level brightness (100% brightness) when motion is detected, and stay on as long as the motion is continuing. When motion is no longer detected, the light will remain on for the predetermined time you set (5~180 seconds), and then revert to low-level brightness you set.
- Light will turn off automatically at dawn, and return to 6 H mode at dusk.

### 4. 0 MODE (nighttime operation only)

- The light will turn to low level brightness (0%~50% brightness) at dusk. The light will turn to high-level brightness (100% brightness) when motion is detected, and stay on as long as the motion is continuing. When motion is no longer detected, the light will remain on for the predetermined time you set (5~180 seconds), and then revert to low level brightness you set.
- Light will turn off automatically at dawn, and return to 0 H mode at dusk.

### 5. Manual Override MODE (nighttime operation only; on at dusk, off at dawn)

- In 3, 6 or 0 mode, to shift to manual override mode, turn off the wall switch in 3 seconds and then turn it on again, the light will turn to high-level brightness at dusk, and turn off automatically at dawn. To return to the previous settings, turn off the wall switch in 3 seconds and then turn it on again. (See Fig.4 Fig.5)
- The lights will turn off automatically at dawn.

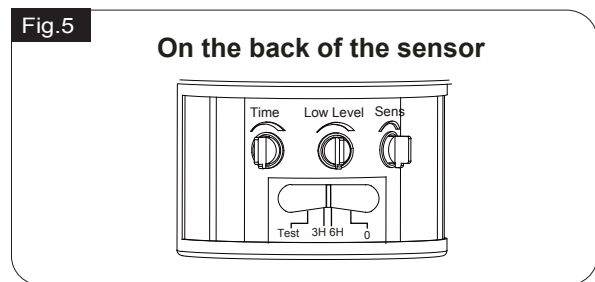
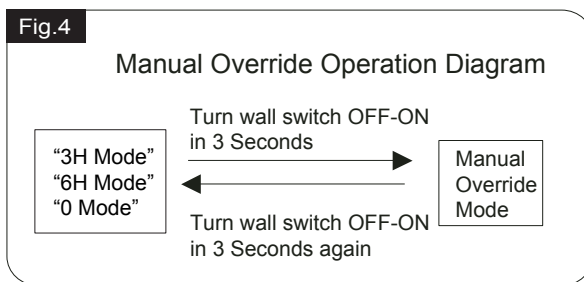

## **CUSTOMIZATION OPTIONS:**

### Shut-off Delay

The Shut-off delay is the length of time the light will stay at high-level brightness after motion has ceased to be detected. This Shut-off delay can be set when operation is in 3, 6 or 0 Mode by using the "TIME" knob located on the left side of the panel at the back of the sensor lens (See Fig.5). To increase the shut-off delay, turn the knob clockwise. To decrease shut off delay, turn the knob counterclockwise. The delay may be adjusted from a minimum of 5 seconds to a maximum of 3 minutes. The light will stay on as long as motion is detected continuously and will automatically turn to low-level brightness when no more motion is detected after the delay time has passed.

### Sensitivity of Motion Sensor

The sensitivity of the motion sensor can be adjusted by using the "Sens" knob located on the right side of the panel at the back of sensor lens (See Fig.5). To increase sensitivity, turn the knob clockwise. To decrease sensitivity, turn the knob counterclockwise. The sensitivity may be adjusted from a minimum of 5 feet to a maximum of 40 feet.

## NOTE:

1. The sensitivity of the motion sensor will increase as the environmental temperature gets cooler. For best performance, gently clean the lens with a soft cloth every 1 or 2 months to assure maximum sensitivity.
2. For best performance, install fixture at least 6 feet above the ground. At such a height, the fixture will provide a detection distance of up to 40 feet at 77 degrees fahrenheit. (See Fig.6)
3. The sensor detects across a detection range of 180 degrees (See Fig.7)
4. The sensor will be more sensitive to motion across its detection path than motion directly towards it. (See Fig.8)
5. To reduce possible nuisances, do not mount the fixture near a heat source like an air conditioner, vent or furnace exhaust, or in a direction facing any reflecting object or other light source.

## Troubleshooting

### ---The light does not come on at all:

1. Make sure the wall switch and circuit breaker are on.
2. Make sure the wiring is correct.
3. Make sure the bulb is not burned out.
4. Cover the sensor with your palm to verify that the ambient light level is not too high.

### ---In Test Mode, the light stays on full brightness after 5 seconds:

1. If during daytime, make sure the slide switch is at the TEST position.
2. If motion continues to be detected.

### ---In 3H or 6H Mode, the light is still on full brightness, even though it has been 3 hours or 6 hours after dusk, respectively:

1. Make sure no motion could be picked up by the sensor.
2. Make sure that mode entry is not in manual override.

### ---After performing 3H or 6H Mode, the light stays on full brightness after 3 minutes:

1. Make sure there is no movement that could be picked up by the sensor.
2. Adjust the time knob counterclockwise to reduce the delay shut-off time.

### ---In 3H or 6H Mode, the light turns off completely, instead of low level brightness, after 3 minutes:

1. Make sure the bulb you installed is a medium base bulb or LED dimmable bulb.
2. Make sure the bulb is in working condition.
3. Make sure the low level is not at the 0% position.

### -- The light blinks:

1. Make sure the light is not mounted near a barbecue, air conditioner or other heat source.
2. Adjust the sensitivity knob counterclockwise to avoid unnecessary triggering like a passing car or reflecting objects.
3. Make sure the bulb is medium base bulb or LED dimmable bulb.

Where you install your light is important: Be sure the light is mounted straight on the wall; otherwise, the detection distance may be limited.

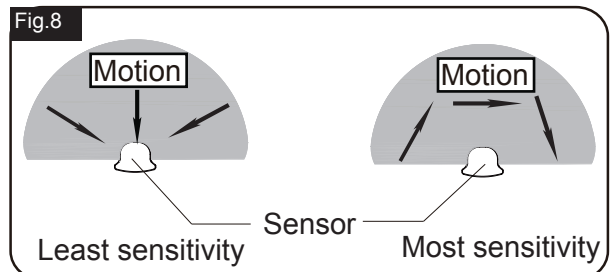
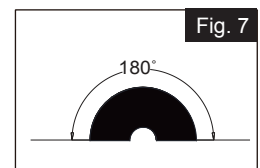
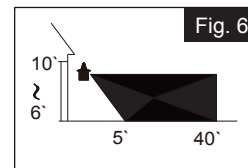

The following parts are available for reorder if damaged or missing.

**Spare Parts List:**

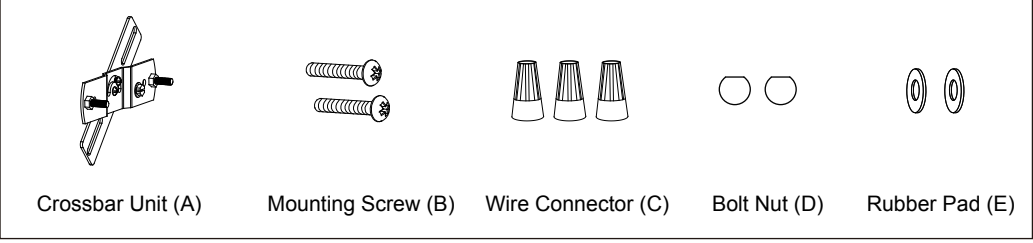

Assembly Kit  
6525MM (1 SET)

Crossbar Unit (A)    Mounting Screw (B)    Wire Connector (C)    Bolt Nut (D)    Rubber Pad (E)

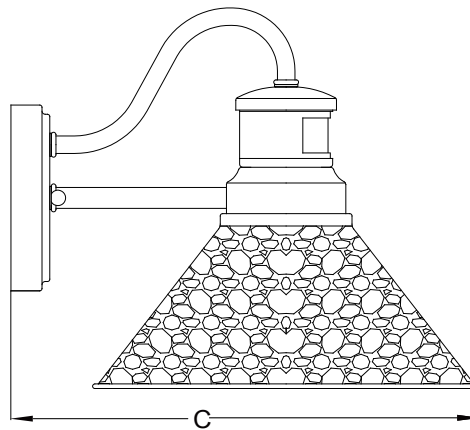
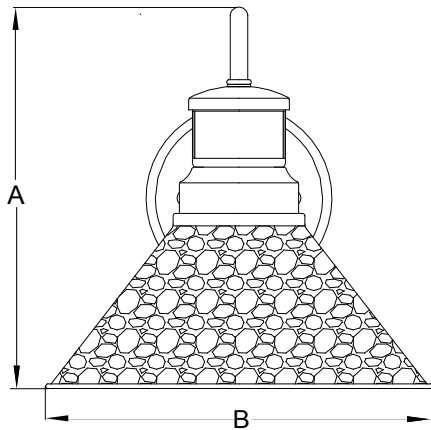

<b>T0669</b>	<b>T0670</b>
<b>A: 9-1/2"</b>	<b>A: 10-1/2"</b>
<b>B: 10"</b>	<b>B: 12"</b>
<b>C: 11-3/4"</b>	<b>C: 14"</b>

### 5 Year Limited Warranty

Vaxcel warrants all of our products against defects in workmanship and finishes for one year following the date of shipment.

In addition:

- Any product with an integrated motion sensor or dusk-to-dawn photocell is supported by a 5-year warranty for the functionality of the product.
- Any product with integrated LED modules is covered by a 5-year warranty on the LED functionality.

*Exclusions: This warranty does not include the failure of products from extreme acts of nature; environmental conditions not suited for the products intended use; operation in temperatures outside of the range specified in the instruction manual; usage with improper power supply, power surges or dips. For coastal locations, some corrosion is considered normal for the environment.*

*Vaxcel reserves the right to repair, replace or issue a credit for any properly installed product, provided it is returned per RMA instruction. This warranty is limited to the cost of the product only and does not extend to transportation, installation or replacement costs.*

How can warranty service be obtained?

info@vaxcel.com  
1-800-482-9235