

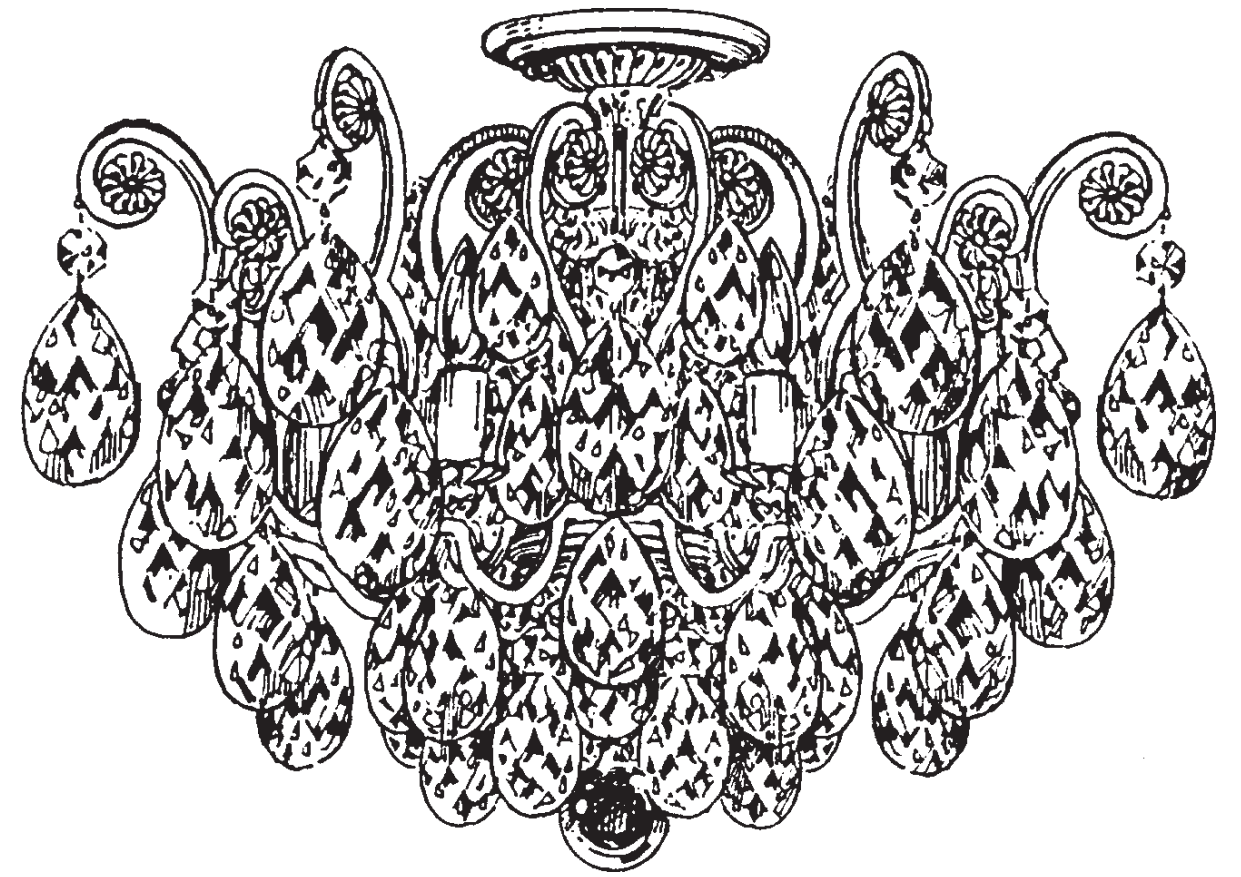

SCHONBEK®

RENAISSANCE 3784- _ _ _



THIS DESIGN IS THE PROPRIETARY TRADE DRESS/TRADemark OF SWAROVSKI LIGHTING, LTD.

6 Lights
Diameter: 20"
Body Length: 15"
Hanging Weight: 18 lbs.



SCHONBEK®

MAX 40 W		110-120 V					

SCHONBEK® is a member of the Swarovski group.

All electrical components must be installed by a licensed electrician in accordance with the National Electric Code and the appropriate local electrical codes.

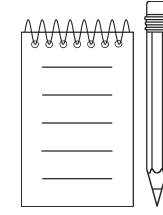
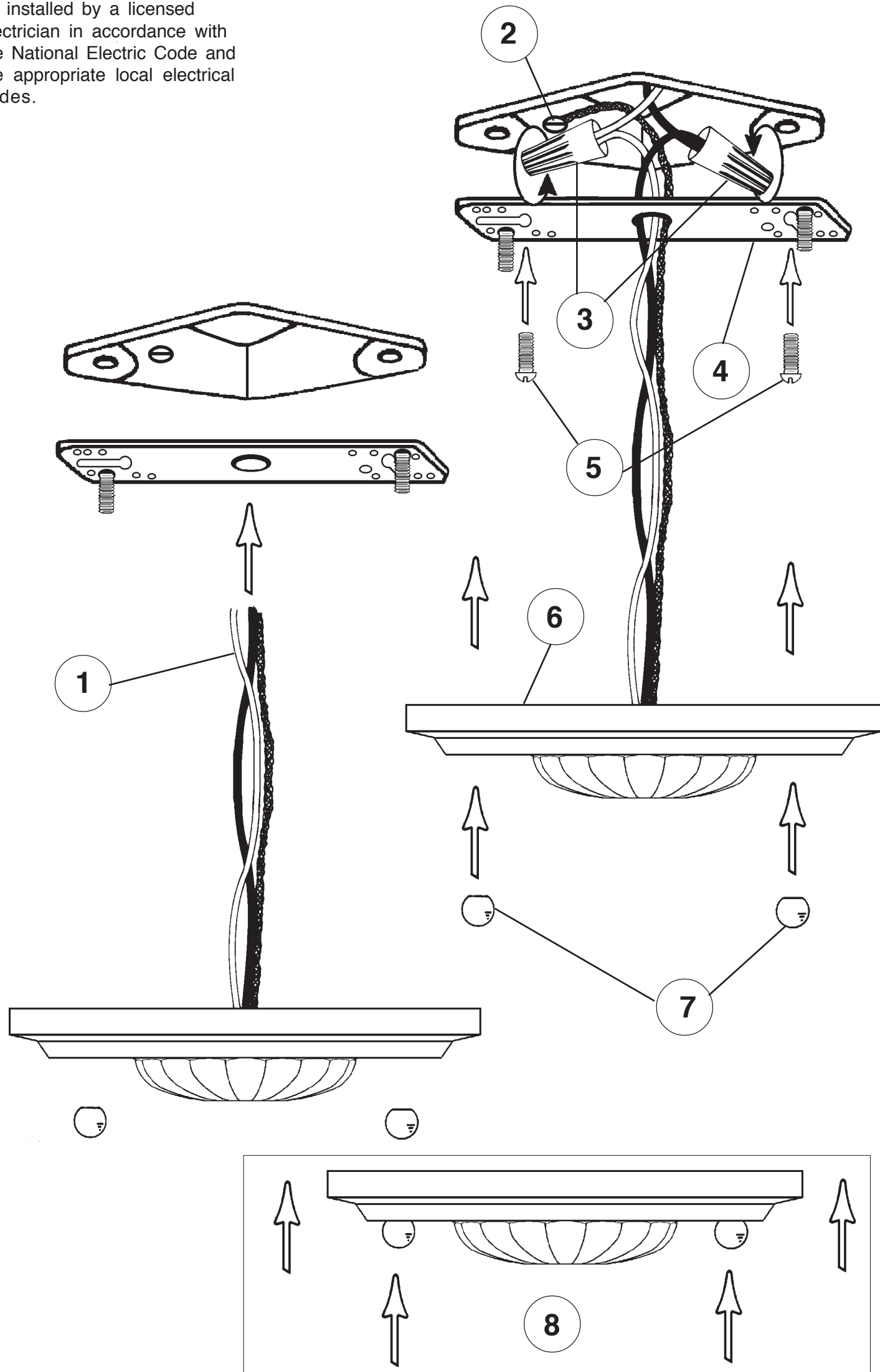

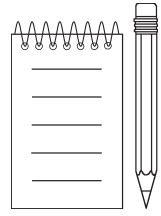

SET #1

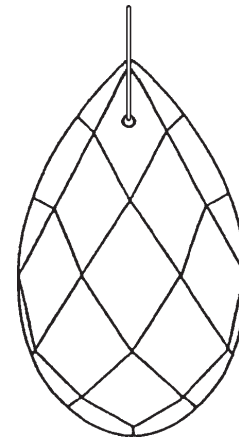

N4014
2-1/2"
63mm

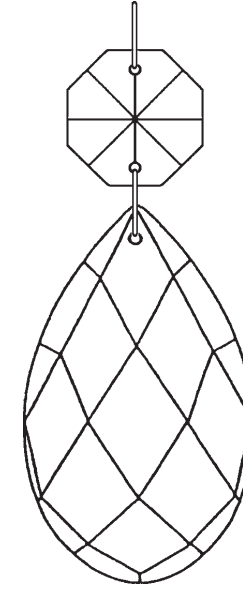

N4003
2-1/2"
63mm

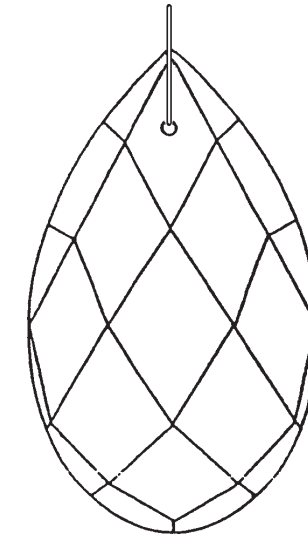

N4004
3"
76mm

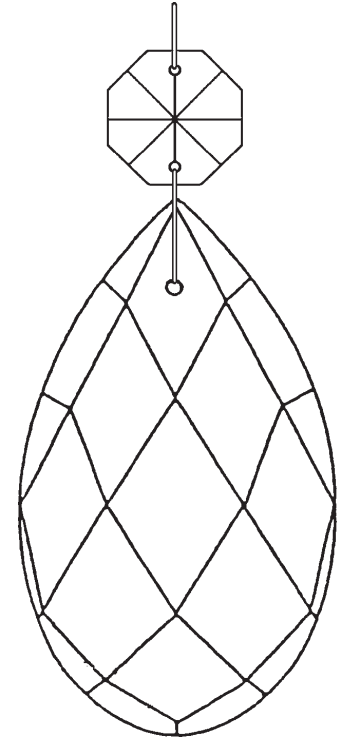

N4007
3-1/2"
89mm

SET #2

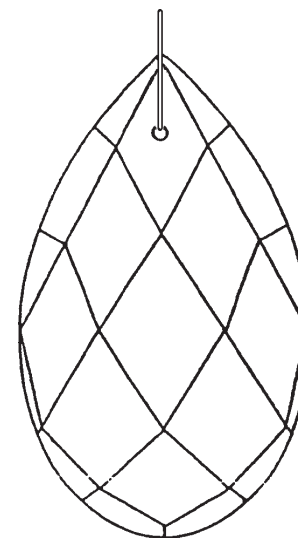

N4004
3"
76mm

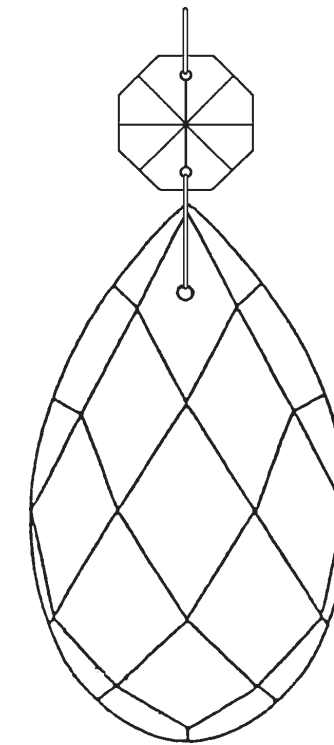

N4007
3-1/2"
89mm

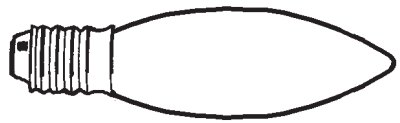

9 6 - B10
40 Watts Max
25 Watts Recommend

Crystal Set #1 in Black

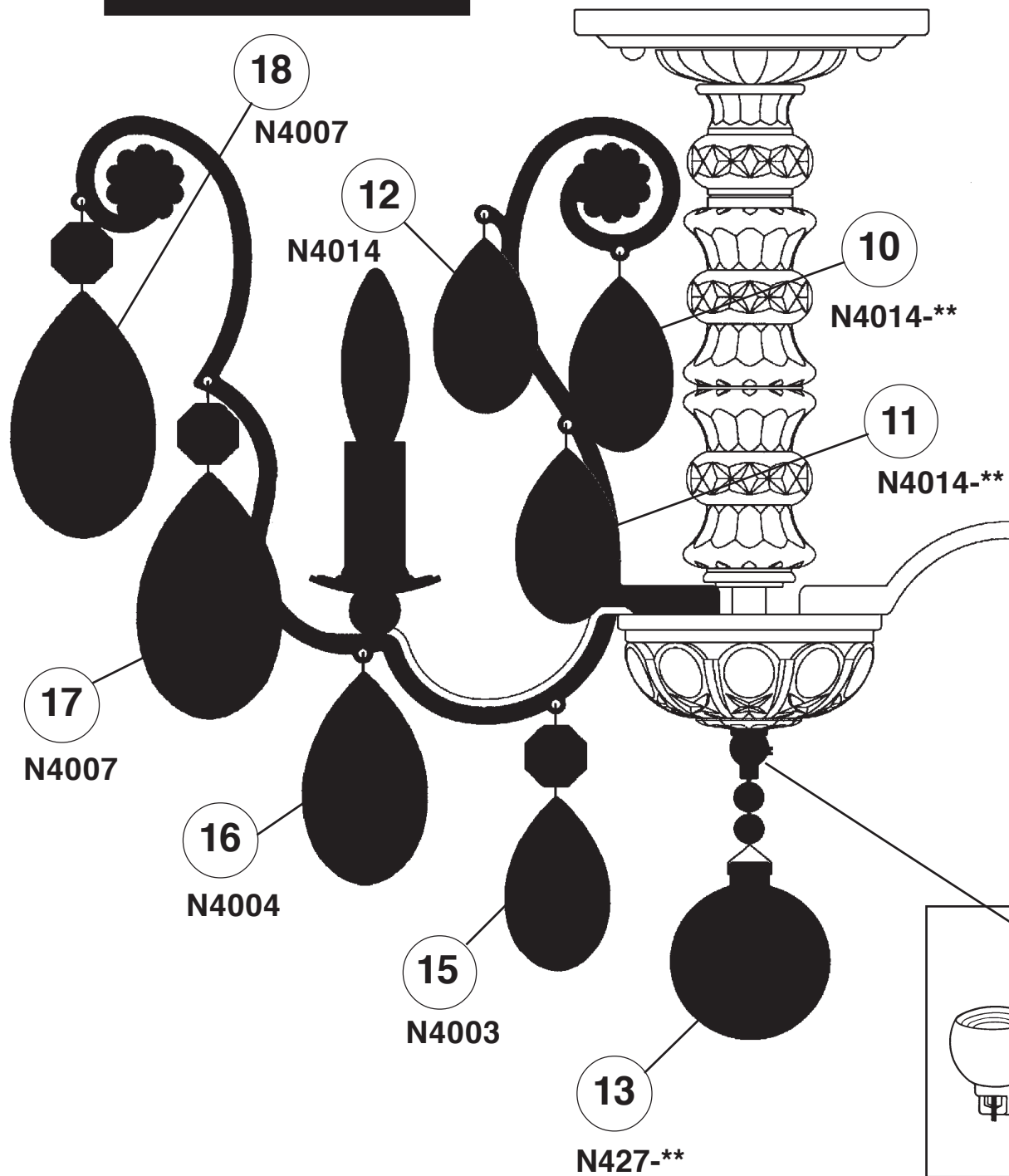

Crystal Set #2 in Black

