

Tools Required

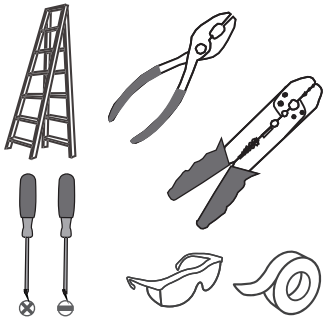

Light Source

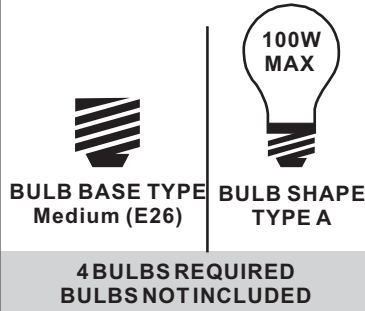

Warnings and Cautions

Turn off the electricity at the circuit breaker before installation. Consult a licensed electrician if in doubt about installation.

Turn off power to the fixture and allow the bulbs to cool before replacing.

Package Contents

Preparation: Identify and inspect all parts before beginning the installation.

Missing or damaged parts? Contact your original place of purchase.

PARTS BAG

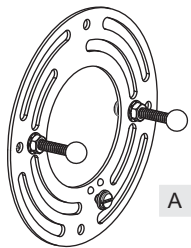

A Crossbar Assembly x 1



B Alternate Mounting Screw x 2



C Outlet Box Screw x 2



D Wire Connector x 3

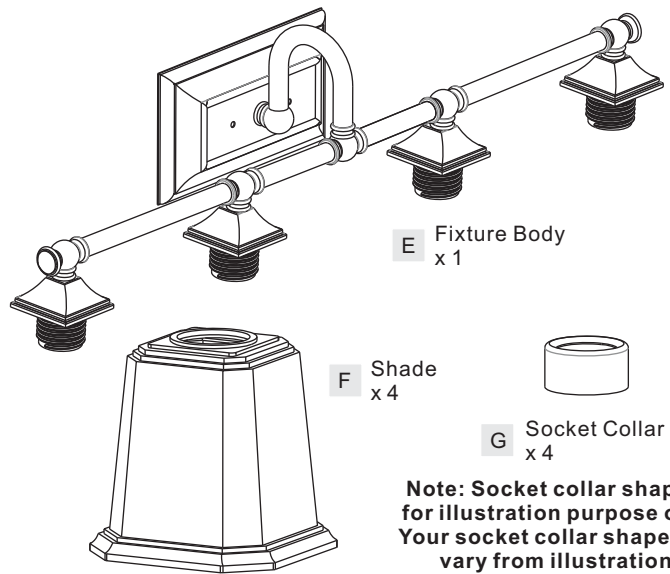

E Fixture Body x 1

F Shade x 4

G Socket Collar x 4

Note: Socket collar shape is for illustration purpose only. Your socket collar shape may vary from illustration.

Table of Contents

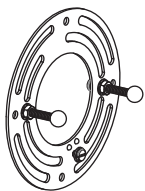
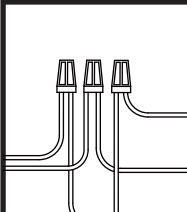
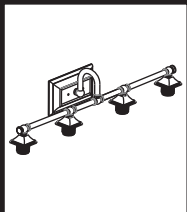
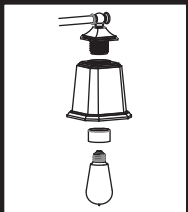
Alternate Mounting Screw	Crossbar Assembly	Wiring	Fixture Body	Shade & Bulb
				
STEP 1	STEP 2	STEP 3	STEP 4	STEP 5

STEP 1

OPTION 1

Standard Mounting Screw

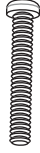

Included (Pre-assembled)

OPTION 2

Alternate Mounting Screw



Included

skip to next page

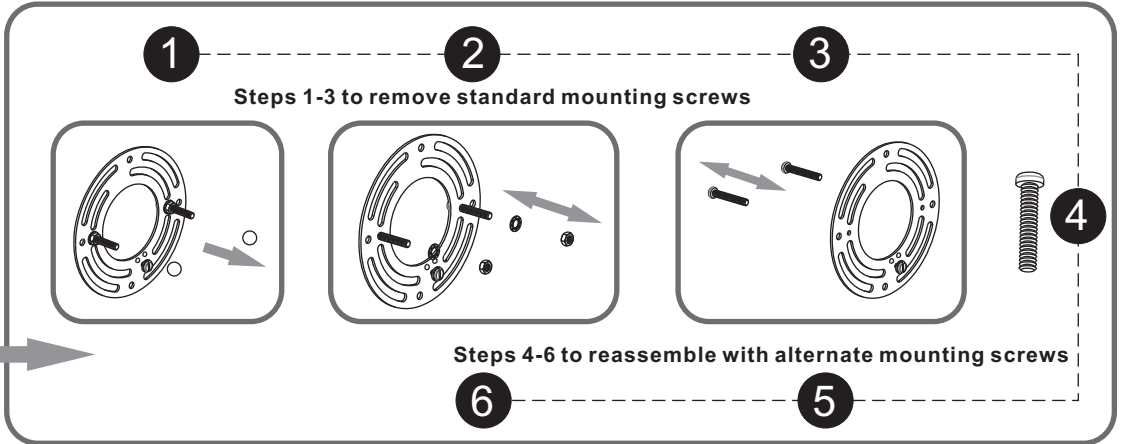

STEP 2

1

Step 1
Install crossbar assembly

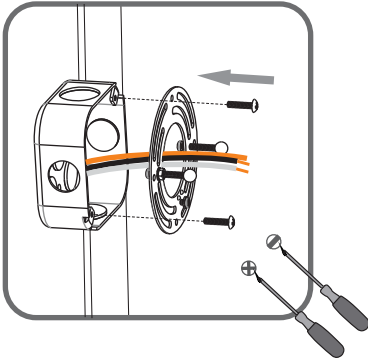

2

Step 2 - 3
Test fitting backplate to mounting screws

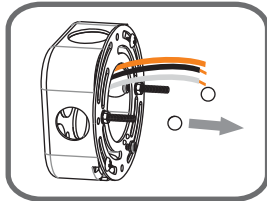

3

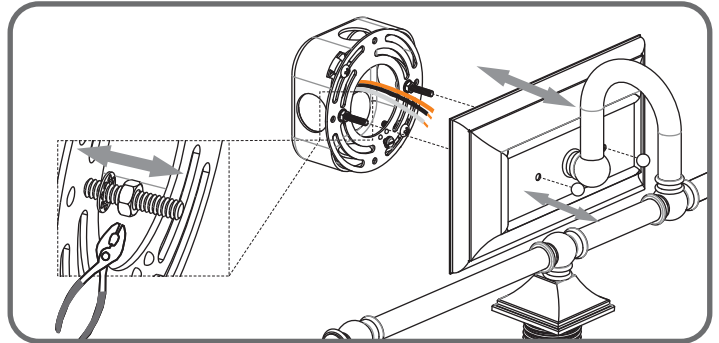

STEP 3

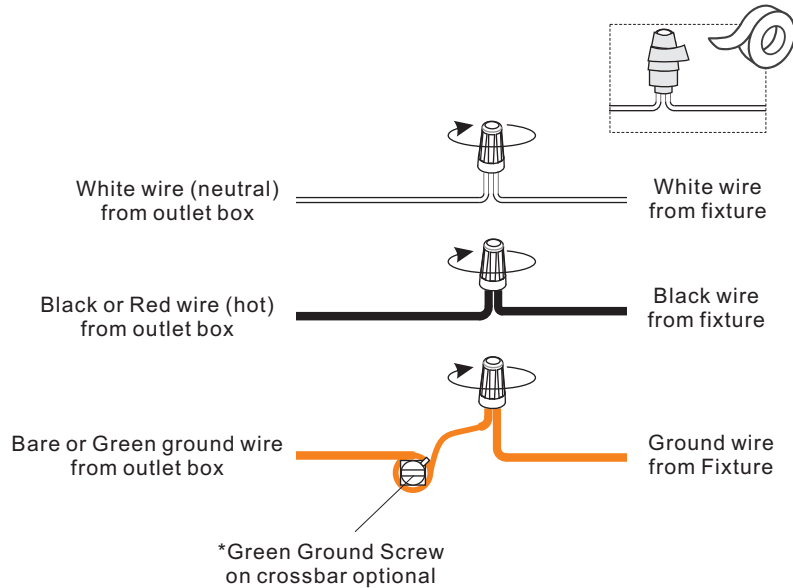

STEP 4

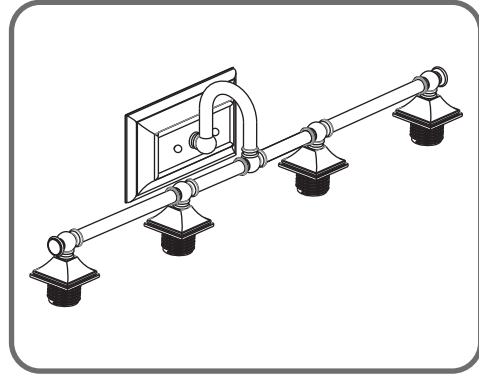
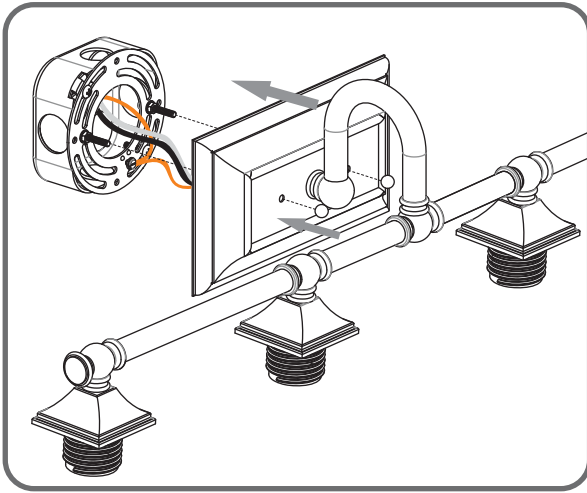

STEP 5

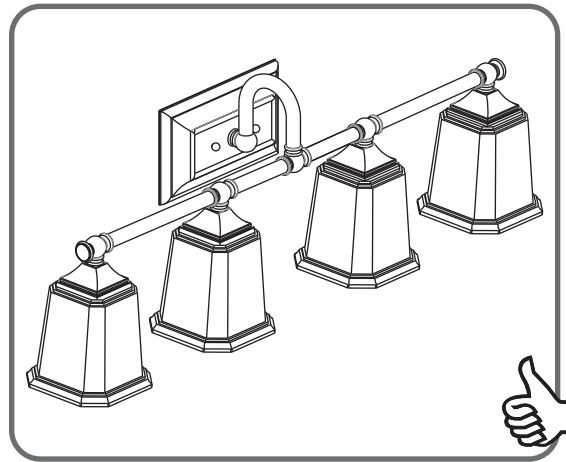
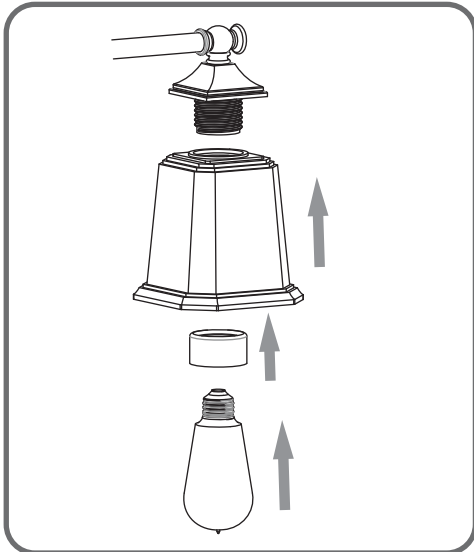

Note: Socket collar shape is for illustration purpose only. Your socket collar shape may vary from illustration.